

SPOTCLEAN™ TURBO AUTOMATE™

MODEL 1558X

What's in the Box?	3	After-Cleaning Care	6
Cleaning Formulas	3	Storing Your Machine	7
Filling the Clean Water Tank	3	Troubleshooting	7
Getting Ready to Clean	4	Warranty	8
Using the Tools	5		

Product Overview

1. Power Switch
2. Power Cable
3. Quick Release Cable Wrap
4. Dirty Water Tank
5. Dirty Water Tank Handle
6. Clean Water Tank Carry Handle
7. Clean Water Tank
8. Hose Grip
9. Spray Trigger
10. Hose Secure Latch
11. Flex Hose

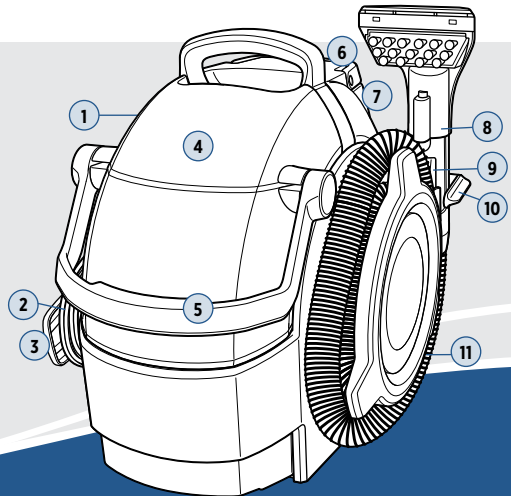

Go online for a comprehensive walkthrough of your new purchase!

This guide has everything you need to get ready for first use, including setting up, using and maintaining your machine, but online you'll find additional resources like tips and troubleshooting, videos, product registration, parts, and more. Go to support.BISSELL.com.

IMPORTANT SAFETY INSTRUCTIONS

READ ALL INSTRUCTIONS BEFORE USING YOUR APPLIANCE. When using an electrical appliance, basic precautions should be observed, including the following:



WARNING

TO REDUCE THE RISK OF FIRE, ELECTRIC SHOCK OR INJURY:

- This appliance can be used by children aged from 8 years and above and persons with reduced physical, sensory or mental capabilities or lack of experience and knowledge if they have been given supervision or instruction concerning use of the appliance in a safe way and understand the hazards involved. Cleaning and user maintenance shall not be made by children without supervision.
- Children should be supervised to ensure that they do not play with the appliance.
- Unplug from electrical socket when not in use, before cleaning, maintaining or servicing the appliance, and if your appliance has an accessory tool with a moving brush, before connecting or disconnecting the tool.
- Do not immerse in water or liquid.
- Keep hair, loose clothing, fingers, and all parts of body away from openings and moving parts of the appliance and its accessories.
- If the supply cable is damaged, it must be replaced by the manufacturer, its service agent or similarly qualified person in order to avoid a hazard.
- Do not run appliance over cable.
- Do not use with damaged cable or plug.
- Do not pull or carry by cable, use cable as a handle, close door on cable, or pull cable around sharp edges or corners.
- Keep cable away from heated surfaces.
- If the appliance has a hand held accessory like pet brush, motor driven head, etc., the user shall avoid entrapment.
- Do not leave appliance when plugged in.
- Use only the type and amount of liquids specified under the operations section of this guide.
- Liquid must not be directed towards equipment containing electrical components.
- Always connect to a properly earthed electrical socket. Do not modify earthed plug.
- Always install float before any wet pick-up operation.
- To unplug, grasp the plug, not the cable.
- Do not handle plug or appliance with wet hands.
- Turn off all controls before unplugging.
- Plastic film can be dangerous. To avoid danger of suffocation, keep away from children.
- Use only as described in this user guide.
- Use only manufacturer's recommended attachments.
- If appliance is not working as it should, has been dropped, damaged, left outdoors, or dropped into water; do not attempt to operate it and have it repaired at an authorised service center.
- Do not put any object into openings.
- Do not use with any opening blocked; keep free of dust, lint, hair, and anything that may reduce air flow.
- Use extra care when cleaning on stairs.
- Do not use to pick up flammable or combustible liquids, such as petroleum, or use in areas where they may be present.
- Do not pick up toxic material (chlorine bleach, ammonia, drain cleaner, etc.).
- Do not use appliance in an enclosed space filled with vapours given off by oil base paint, paint thinner, some moth-proofing substances, flammable dust, or other explosive or toxic vapours.
- Do not pick up hard or sharp objects such as glass, nails, screws, coins, etc.
- Do not pick up anything that is burning or smoking, such as cigarettes, matches or hot ashes.
- Do not use without filters in place.
- Do not expose to rain. Store indoors.
- Floor slippery when wet.

SAVE THESE INSTRUCTIONS

ORIGINAL INSTRUCTIONS.

FOR OPERATION ON A 220-240 VOLT A.C. 50-60 HZ POWER SUPPLY ONLY.



THIS MODEL IS FOR HOUSEHOLD USE ONLY.

IMPORTANT INFORMATION

- Keep appliance on a level surface.
- If your appliance has a motorised Brush Roll, do not leave machine running in the same spot without the handle fully upright.
- To reduce the risk of a leaking condition, do not store unit where freezing may occur. Damage to internal components may result.
- Plastic tanks are not dishwasher safe. Do not put tanks in dishwasher.

What's in the Box?

Standard accessories may vary by model. To identify what should be included with your purchase, please refer to the "Carton Contents" list located on the carton top flap.

		
Body	Tools (varies by model)	Full-Size Formula (varies by model)

Filling the Formula Tank

Find more formulas at BISSELL.com.

Choosing Your Desired Formula

Always use genuine BISSELL® formulas in your machine. Other formulas may harm the machine and void the warranty.

			
Clean + Protect Removes deep down dirt	PET Stain & Odor Removes tough pet messes	PRO MAX Clean + Protect Our most powerful formula for tough, ground-in dirt & stains	PET PRO OXY Urine Eliminator Our best formula for tough pet messes

Filling the Clean Water Tank

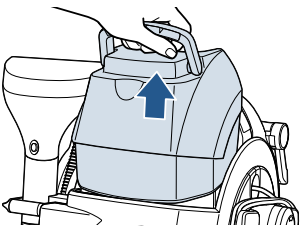
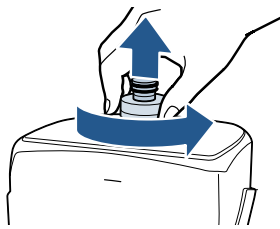
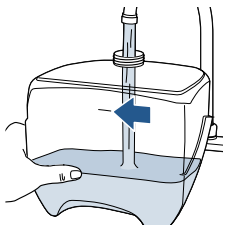
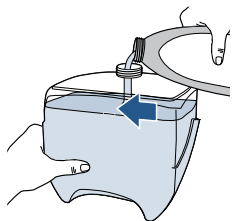
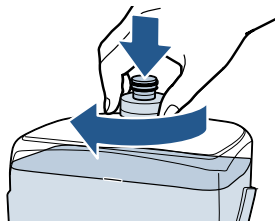
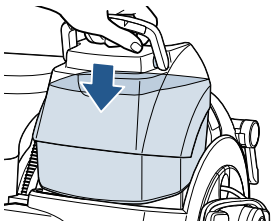
		
1. Remove tank from the back of the machine by lifting the Clean Water Tank Carry Handle.	2. Unscrew the black cap and remove bottle insert.	3. Fill tank with warm tap water (140° F/60° C MAX) to the water fill line.
		
4. Add 60 mL/2 oz of BISSELL formula to the tank.	5. Place bottle insert back into tank and tighten the black cap.	6. Place the tank back onto the machine.

Getting Ready to Clean

Tools vary by model. To shop all tools and accessories, visit [BISSELL.com/parts](https://www.bissell.com/parts).

Before You Clean

1. Vacuum to remove loose dirt from area to be cleaned.
2. Spray any BISSELL® stain pretreat formula to soiled areas or stains.
3. Allow to sit for at least 3 minutes.
4. Clean following instructions below.

Choose Your Desired Tool

Tools vary by model.

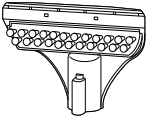

15 cm Tool

Great for cleaning stairs and larger furniture areas.

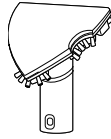

3-in-1 Stair Tool

Made for tricky areas like curves, corners and tread of carpeted stairs.



Crevice Tool

Best for narrow spaces and crevices that are hard to reach.



HydroRinse™ Self-Cleaning Hose Tool

Use to clean out your hose after each use.

Using the Tools

▶ Search your tool on support.BISSELL.com for how-to videos.

Attaching and Using the Tool

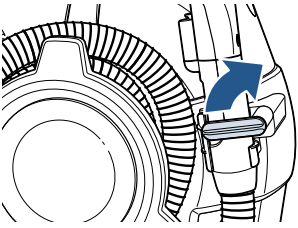

1. Release the hose by twisting the secure latch.

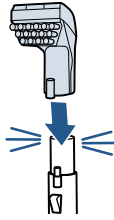

2. Attach your desired tool to the Hose Grip until you hear a "click".

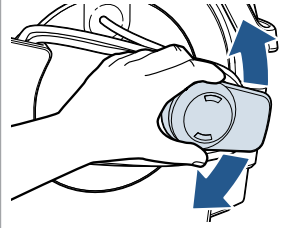

3. Twist the Quick Release Cable Wrap and unwind the cable to plug into outlet.

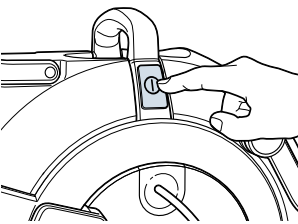

4. Press the Power Switch ON.

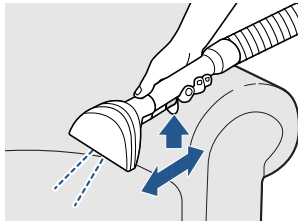

5. Point the tool approximately 1 inch above the spot or stain and press the Spray Trigger.

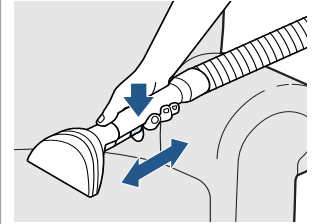

6. Release the Spray Trigger and use the bristles to scrub the area. To lift away the stain, apply downward pressure while moving the tool slowly toward you.

Using the HydroRinse™ Tool



1. Hold the hose and tool in an upright position with the machine ON. Hold down the trigger for 30 seconds. Be sure to empty the Dirty Water Tank after use (see page 6).

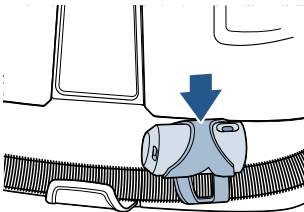

2. You can store tool on machine, as shown.

Emptying the Dirty Water Tank

↖ We have additional tips for maintaining your machine at support.BISSELL.com.

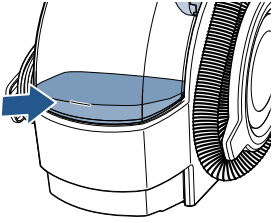

1. When the Dirty Water Tank reaches the "FULL" line it is time to empty.

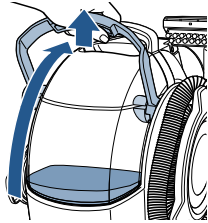

2. Remove Dirty Water Tank and carry to disposal area.

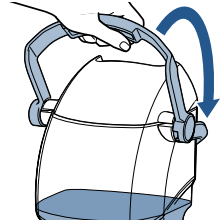

3. Unlock by rotating the handle up and over the back of the tank.

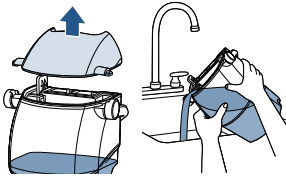

4. Remove lid and pour out dirty water. Rinse out tank to remove any debris.

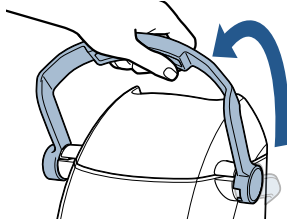

5. Replace the tank lid and rotate the handle forward to lock back into place.

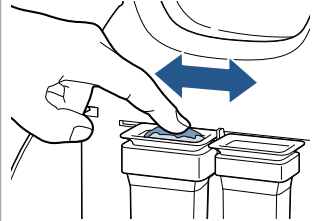

6. Before placing tank back into the machine, remove any debris from the red filter.

⚠ WARNING To reduce the risk of fire, electric shock or injury, turn power OFF before performing maintenance or troubleshooting.

Cleaning Your Machine

↖ For more helpful maintenance tips, check out support.BISSELL.com.

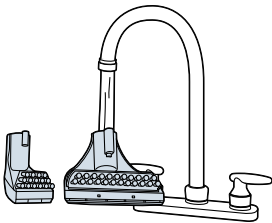

1. Remove and rinse the tools under clean, running water. Allow tools to dry.

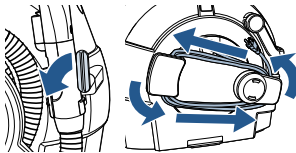

2. Wrap and secure the Flex Hose and Power Cable.

Storing Your Machine

Store machine in protected, dry area at room temperature (4° C - 40° C).

Troubleshooting

Below are some of the issues you may run into. If you don't see the issue you're experiencing below, visit support.BISSELL.com.

Problem	Possible Cause	Remedies
Reduced Spray or No Spray	Spray nozzle clogged.	Clean spray nozzle using an unfolded paper clip.
	Clean Water Tank empty.	Check/fill tank.
	Clean Water Tank insert clogged.	Clean insert at bottom of Clean Water Tank.
	Pump needs priming.	Gently lift Clean Water Tank while pressing the spray trigger OR gently squeeze clean tank while pressing spray trigger.
	Clean Water Tank not fully seated.	Remove and reseal Clean Water Tank.
Carpet Cleaner Won't Pick Up Cleaning Solution	Poor tool position.	Reposition on surface, follow recommended cleaning procedures.
	Dirty Water Tank is full.	Empty Dirty Water Tank.
	Excess solution in Flex Hose.	Lift tool and point upwards to allow water in hose to flow into the Dirty Water Tank.
	Incorrect cleaning formula.	Use BISSELL® Portable Machine formulas only.
	Dirty Water Tank is improperly seated onto base.	Remove and reseal tank.
Dirty Water Tank Leaking	Dirty tank plug is unplugged.	Push in Dirty Water Tank plug until properly sealed.
	Duckbill valve is dirty.	Clean the duckbill valve located at the bottom of the Dirty Water Tank. Once cleaned, make sure it is placed securely back in place.
	Float stack not fully locked on Dirty Water Tank.	Remove float stack and twist until arrow is aligned with lock symbol on Dirty Water Tank.
	Dirty Water Tank not properly seated onto machine.	Remove and reseal onto machine.

Note: Any other servicing should be performed by an authorized service representative.

NOTICE To reduce the risk of a leaking condition, do not store machine where freezing may occur. Damage to internal components may result.

⚠ WARNING To reduce the risk of electric shock, turn power OFF and disconnect from electrical outlet before performing maintenance or troubleshooting.

Warranty

This warranty gives you specific legal rights, in addition to rights you may have under the *Australian Consumer Law*. If you need additional instruction regarding this warranty or have questions regarding what it may cover, please contact your local BISSELL® Consumer Care on the details set out below.

It may be necessary to obtain some of your personal information, such as a mailing address, to fulfill terms of this warranty. Any personal data will be handled pursuant to BISSELL's Privacy Policy, which can be found at global.BISSELL.com/privacy-policy.

BISSELL® Two-Year Warranty

Subject to the *conditions identified below, BISSELL will repair or replace (with new, refurbished, lightly used, or remanufactured components or products), at BISSELL's option, free of charge from the date of purchase by the original purchaser, for two years any defective or malfunctioning part due to manufacturer defect. This warranty applies to product used for personal purposes, and not commercial or rental service. This warranty does not apply to fans or routine maintenance or consumable components such as filters, belts, brush rolls, etc., damage or malfunction caused by negligence, abuse, neglect, unauthorized repair, or any other use not in accordance with the user guide. BISSELL recommends that the original packaging be kept for the duration of the warranty period in case such need arises within the warranty period that the item needs re-packing and transportation.

*Conditions of Warranty

Subject to whether such loss is reasonably foreseeable, BISSELL and its in-country distributors are not liable for incidental or consequential damages of any nature associated with the use of this product.

This warranty is in addition to other rights or remedies under law. Nothing in this warranty excludes, limits or modifies any liability of BISSELL which is imposed by law, or limits or modifies any remedy available to the consumer which is granted by law. To make a claim under this warranty contact BISSELL Australia PTY LTD (details below). Contact BISSELL prior to returning any goods. Where agreed, BISSELL will reimburse reasonable postage / handling costs (if any) for returning goods to BISSELL. To claim expenses incurred in making a claim under this warranty please provide BISSELL with a copy of the receipt of the expenses by email or post.

For Australian Consumers Only: Our goods come with guarantees that cannot be excluded under the *Australian Consumer Law*. You are entitled to a replacement or refund for a major failure and compensation for any other reasonably foreseeable loss or damage. You are also entitled to have the goods repaired or replaced if the goods fail to be of acceptable quality and the failure does not amount to a major failure.

Consumer Care

Australia

Telephone: 1300 247 735

Website: www.BISSELL.com.au

New Zealand

Telephone: 0800 247 735

Website: www.BISSELL.co.nz

But wait, there's more!

Join us online for a complete guide to your new product, including troubleshooting, parts and more. **Go to BISSELL.com.**



INFO



VIDEOS



PARTS



©2020 BISSELL Inc. All rights reserved.
Part Number 1625536 09/20 RevC