

Bissell®

TURBOCLEAN POWERBRUSH

USER GUIDE
2222F

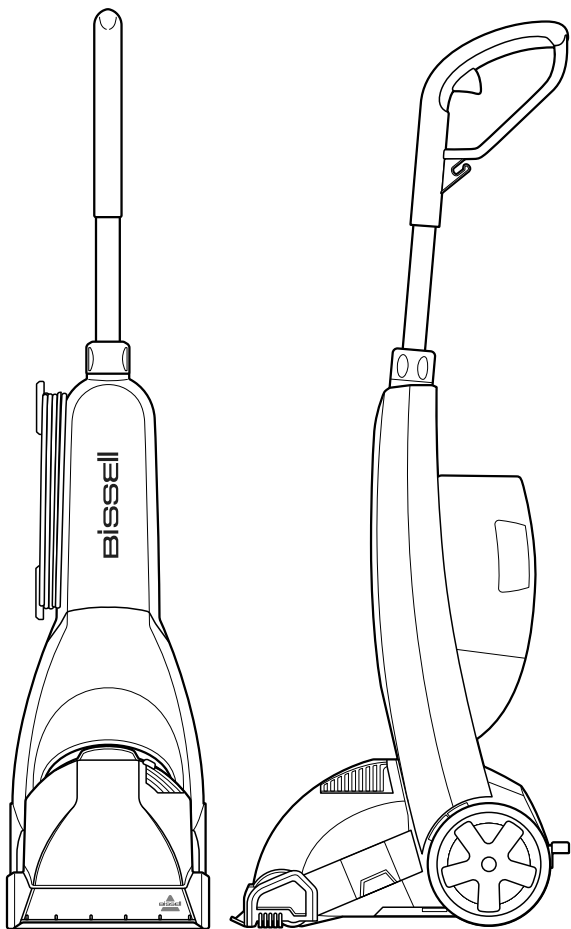

IMPORTANT SAFETY INSTRUCTIONS

READ ALL INSTRUCTIONS BEFORE USING YOUR APPLIANCE.

Unplug from outlet when not in use and before conducting maintenance. When using an electrical appliance, basic precautions should be observed, including the following:

WARNING

TO REDUCE THE RISK OF FIRE, ELECTRIC SHOCK OR INJURY:

- » This appliance can be used by children aged from 8 years and above and persons with reduced physical, sensory or mental capabilities or lack of experience and knowledge if they have been given supervision or instruction concerning use of the appliance in a safe way and understand the hazards involved. Cleaning and user maintenance shall not be made by children without supervision.
- » Children should be supervised to ensure that they do not play with the appliance.
- » Keep hair, loose clothing, fingers, and all parts of body away from openings and moving parts of the appliance and its accessories.
- » Unplug from electrical socket when not in use, before cleaning, maintaining or servicing the appliance, and if your appliance has an accessory tool with a moving brush, before connecting or disconnecting the tool.
- » If the supply cable is damaged, it must be replaced by the manufacturer, its service agent, or similarly qualified person in order to avoid a hazard.
- » Do not run appliance over cable, a hazard may occur.
 - » Do not leave appliance when plugged in.
 - » Do not use with damaged cable or plug.
 - » Do not pull or carry by cable, use cable as a handle, close door on cable, or pull cable around sharp edges or corners.
 - » Keep cable away from heated surfaces.
 - » To unplug, grasp the plug, not the cable.
- » Do not handle plug or appliance with wet hands.
- » Turn OFF all controls before unplugging.
- » Plastic film can be dangerous. To avoid danger of suffocation, keep away from children.
- » Use only as described in this user guide.
- » Use only manufacturer's recommended attachments.
- » Do not immerse in water or liquid.
- » If appliance is not working as it should, has been dropped, damaged, left outdoors, or dropped into water; do not attempt to operate it and have it repaired at an authorized service center.
- » Do not put any object into openings.
- » Do not use with any opening blocked; keep free of dust, lint, hair, and anything that may reduce air flow.
- » Use extra care when cleaning on stairs.
- » Do not use to pick up flammable or combustible liquids, such as petroleum, or use in areas where they may be present.
- » Do not pick up toxic material (chlorine bleach, ammonia, drain cleaner, etc).
- » Do not use appliance in an enclosed space filled with vapours given off by oil-based paint, paint thinner, some moth-proofing substances, flammable dust, or other explosive or toxic vapours.
- » Do not pick up hard or sharp objects such as glass, nails, screws, coins, etc.
- » Keep appliance on a level surface.
- » Do not pick up anything that is burning or smoking, such as cigarettes, matches or hot ashes.
- » Have servicing performed by a qualified repair person using only identical replacement parts. This will ensure that the safety of the product is maintained.
- » Operators shall be adequately instructed on the use of these machines.
- » Always connect to a properly earthed electrical socket. Do not modify earthed plug.
- » Liquid must not be directed towards equipment containing electrical components.
- » Do not immerse. Use only on surfaces moistened by the cleaning process. Use only BISSELL cleaning products intended for use with this machine.
- » Use only the type and amount of liquids specified under the operations section of this guide.
- » Use indoors only.
- » Have servicing performed by a qualified repair person using only identical replacement parts. This will ensure that the safety of the product is maintained.
- » Operators shall be adequately instructed on the use of these machines.

SAVE THESE INSTRUCTIONS

FOR OPERATION ON A 220-240 VOLT A.C. 50-60 HZ POWER SUPPLY ONLY.

This model is for household use only.

Thanks for buying a BISSELL® carpet washer!

We love to clean and we're excited to share one of our innovative products with you. We want to make sure your carpet washer works as well in one year as it does today, so this guide has tips on using, maintaining, and if there is a problem, troubleshooting.

In just a few simple assembly steps, you'll be ready to deep clean. Flip to page 5 and let's get started!

What's In The Box?



Upper Body

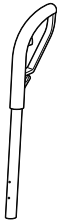

Handle Post

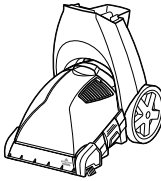

Lower Body



Clean Water Tank

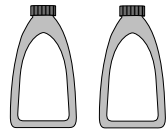

Trial-Size Formulas

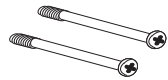

Two Screws
(taped to handle)

NOTE: Standard accessories may vary by model. To identify what should be included with your purchase, please refer to the "Carton Contents" list located on the carton top flap.

Safety Instructions.....2
Product View.....4
Assembly5
Cleaning Formulas.....6
Operations7-9

Maintenance & Care 10-12
Troubleshooting 14
Guarantee..... 16
Consumer Care..... 16

Product View

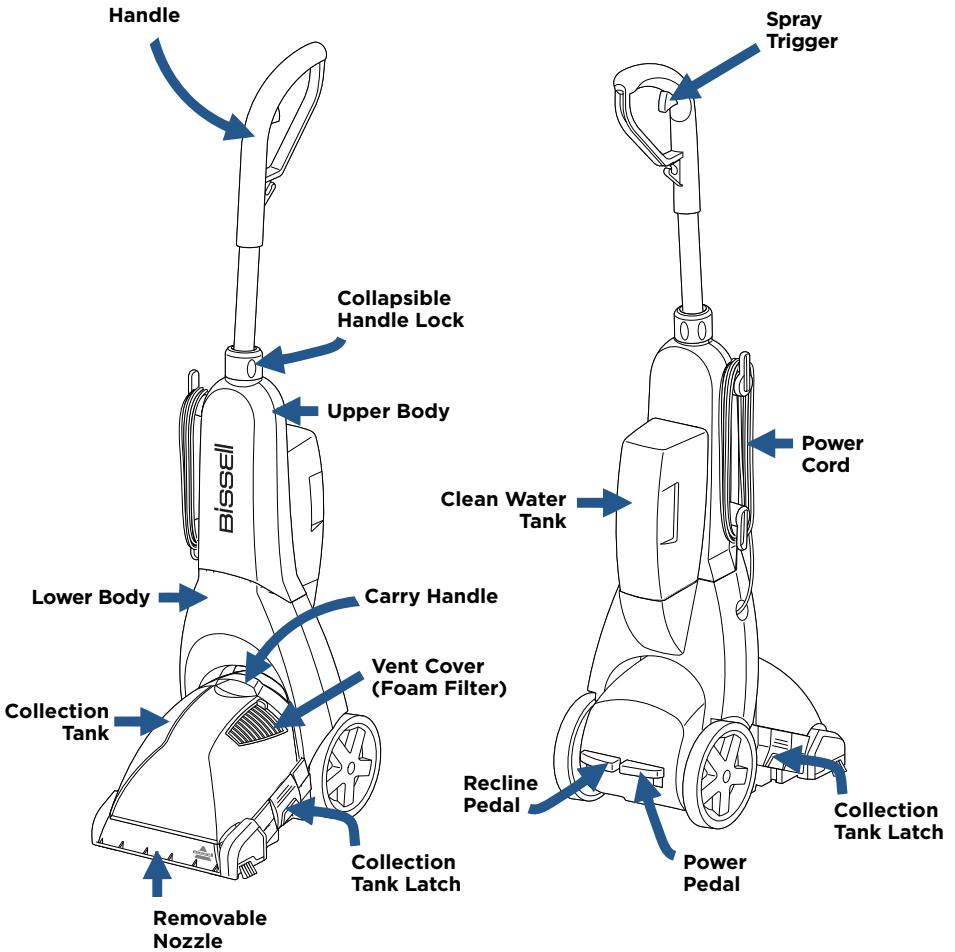

Assembly

WARNING

Do not plug in your carpet washer until you are familiar with all instructions and operating procedures.

A Phillips-head screwdriver is required for Assembly in Step 2.

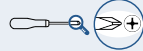

1

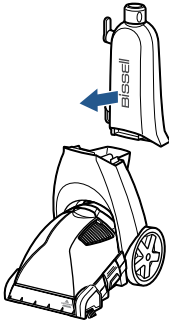

Slide Upper Body onto Lower Body.

2

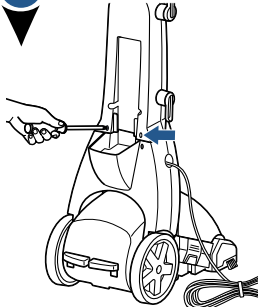

Secure with screws.

3

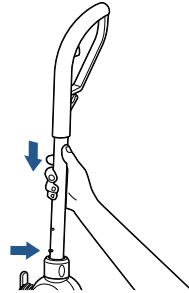

Slide upper Handle Post into the body by aligning the pin and sliding the post down into place.

4

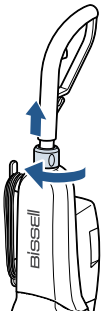

Be sure to secure upper handle before lifting. Rotate lock collar to secure.

5

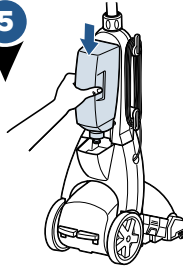

Place Clean Water Tank on back of machine, so it "clicks" into place.

6

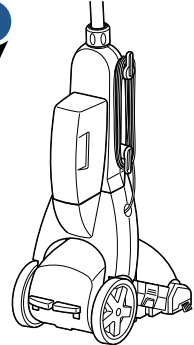

Wrap Power Cable.

Tips Before Carpet Cleaning



- If cleaning an entire room, consider moving your furniture to another area.
- Remove loose dirt and impediments before cleaning.
- Pretreat stains with BISSELL® Pretreat to improve performance on coffee stains and ground-in dirt.

Cleaning Formula

Keep plenty of BISSELL® formulas on hand so you can clean whenever it fits your schedule. Always use genuine BISSELL formulas in your machine. Other formulas may harm the machine and void the guarantee.

Carpet Cleaning Formulas

Wash & Protect			Wash & Refresh
			
Pro Stain & Odour Professional strength to remove extra tough stains and odours.	Pet Stain & Odour Removes tough pet stains and odours.	Stain & Odour Removes tough stains and odours.	Ambipur Blossom & Breeze Powerful cleaning with a refreshing spring scent.

Wash & Remove	
	
Pro Pet Urine Eliminator + Oxy Permanently removes stains and odors at the source with the power of Oxy.	Allergen Helps remove pet dander, pollen and dust mite waste allergens.

Pretreat

Pretreat spots and stains to improve carpet cleaning performance.

	
Stain Pretreat Loosens set-in stains & odours before carpet washing.	Pet Stain Pretreat Loosens tough pet stains & odours before carpet washing.

Boost

Add Boost carpet cleaning formula enhancers to any formula to increase its effectiveness.



Oxy Boost Add to formula for permanent stain removal.

Certain trademarks used under license from The Procter & Gamble Company or its affiliates.

⚠️ WARNING To reduce the risk of fire and electric shock due to internal component damage, use only BISSELL formula intended for use with this machine. Use of cleaning formulas that contain eucalyptus, lemon or pine oil may damage this appliance and void the guarantee. Chemical spot cleaners or solvent-based soil removers should not be used. These products may react with the plastic materials used in your carpet washer causing cracking or pitting.

Filling the Clean Water Tank

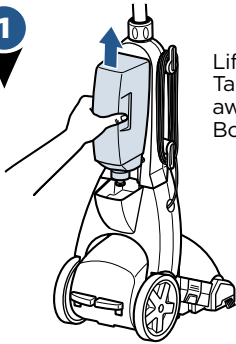
1



Lift the Clean Water Tank straight up and away from the Lower Body to remove.

2

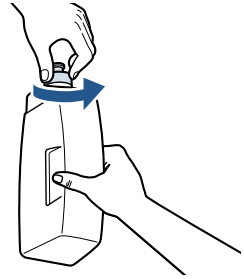

Unscrew the cap at the bottom of the Clean Water Tank.

3

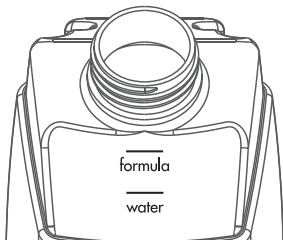

Fill with warm tap water to the WATER line. Fill the rest of the tank with BISSELL Formula to the FORMULA line.

4



Replace and tighten the cap, then return the Clean Water Tank to Lower Body. It will “click” into place when seated properly.

A few notes about filling the clean water tank:

- Fill with warm (140°F/60°C MAX) tap water and add the appropriate BISSELL® formula. **DO NOT USE BOILING WATER. DO NOT HEAT WATER OR TANK IN MICROWAVE.**

NOTICE: Do not overwet carpet. Be careful not to run over loose objects or edges of area rugs. Stalling the brush may result in premature belt failure.

NOTE: Do not substitute BISSELL® Formula cleaning solution with other household cleaning products.



Pour in more power with BISSELL OXY Boost

- Fill tank with water and BISSELL cleaning formula.
- Add 29.5 ml of BISSELL OXY Boost per 1.89 Liter of water.
- TurboClean PowerBrush has a 1.89-Liter tank.

Cleaning Your Carpet

Important! Please check manufacturer's tag before cleaning area rugs for any specialized cleaning instructions. We do not recommend deep cleaning delicate, silk, wool, antique, or area rugs, without a manufacturer's tag.

1

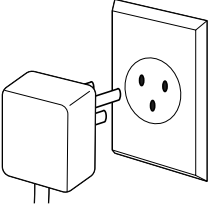

Plug into a proper outlet.

2

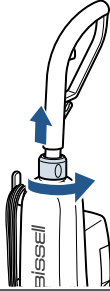

Extend the Collapsible Handle Post by turning the collar counter-clockwise and lifting the handle up. Turn the collar clockwise to secure.

IMPORTANT BEFORE USE: Make sure the Handle Post is fully extended up and the collar lines up with the lock symbol before you begin cleaning.

3

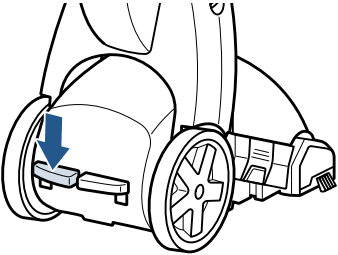

With foot, press the grey Recline Lever located next to Power Pedal.

4

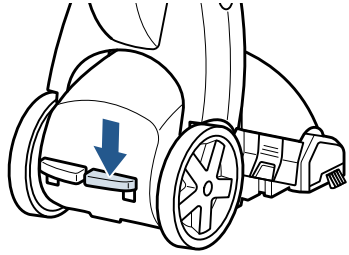

With foot, press the red Power Pedal, located on the back of the machine.

5



Cleaning Pass:

1. While pressing the trigger, make one slow forward wet pass and another one back.
2. Release the trigger and make one slow forward and backward pass over the same area.
3. Repeat steps 1 and 2 until solution being pulled up appears clean.
4. Empty the Dirty Water Tank when dirty water reaches the full line, and fill with fresh warm water and formula when the Clean Water Tank is empty.

Emptying the Dirty Water Tank

⚠️ WARNING

To reduce the risk of fire, electric shock or injury, turn power OFF and disconnect plug from electrical outlet before performing maintenance or troubleshooting.

1

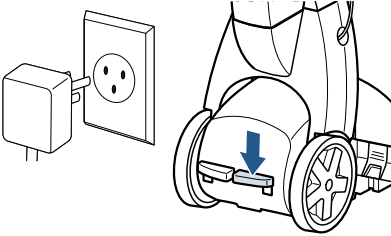

With foot, press the red Power Pedal, to turn OFF machine and then unplug.

2

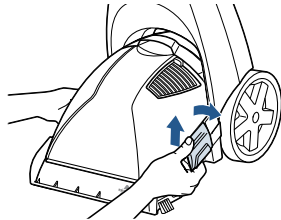

Release Dirty Water Tank Latches (on each side) by pulling up from the bottom of latch and then out.

3

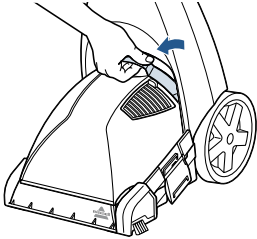

Carefully remove tank by lifting up on the Carry Handle.

4

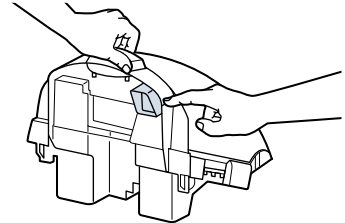

Carry the Dirty Water Tank to a sink. To empty, tilt tank and pour out contents using the opening at the back of tank.

5

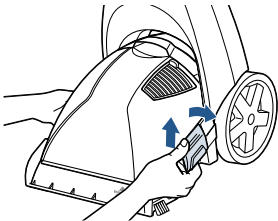

Rinse the Dirty Water Tank thoroughly and replace on machine. Secure latches on both sides of the tank.

6

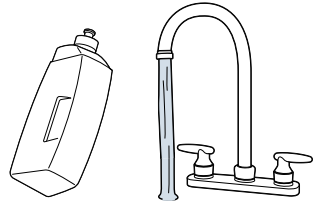

Refill the Clean Water Tank and continue cleaning, or if you're done cleaning, wait for the pieces to dry before storing your machine.

Cleaning Your Machine After Use

WARNING

To reduce the risk of electric shock, turn power OFF and disconnect plug from electrical outlet before performing maintenance or troubleshooting checks.

1

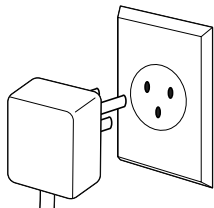

Unplug the machine.

2

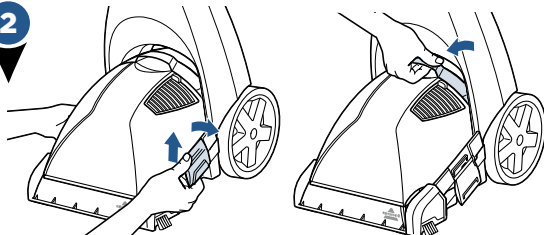

Remove and rinse the Dirty Water Tank thoroughly.

3

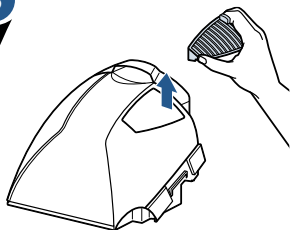

Remove tank vent & foam filter (located on top of the Dirty Water Tank) and rinse.

4

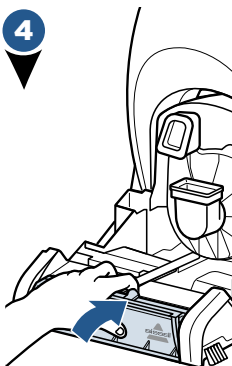

To remove and clean the nozzle, keep the Dirty Water Tank off of the machine.

Gently pull the two tabs that point up near the front of the machine. The nozzle will unhook to remove. Rinse under running water. When finished, slightly tilt the machine so the foot raises up so you can align the nozzle hooks at the floor of the machine. Rotate the nozzle up to clip back into place.

5

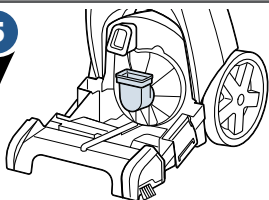

Remove lint and hair from red gasket in base of machine. (Do not remove gasket.)

6

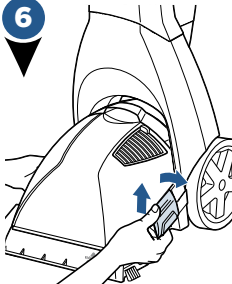

Once the parts have been rinsed clean and dried, replace the Dirty Water Tank to the base of the machine and secure with both latches. Wrap power cable around Quick Release Cable Wrap on side of the machine. Wipe all surfaces with a soft cloth and store machine upright in a protected, dry area.

NOTICE: To reduce the risk of a leaking condition, do not store machine where freezing may occur. Damage to internal components may result.

Replacing the Belts & Brush Rolls

⚠️ WARNING

To reduce the risk of electric shock, turn power OFF and disconnect plug from electrical outlet before performing maintenance or troubleshooting checks.

What you will need: 1 Phillips-head screwdriver & 1 flathead screwdriver

1

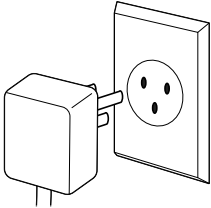

Turn the machine OFF and unplug from wall outlet.

2

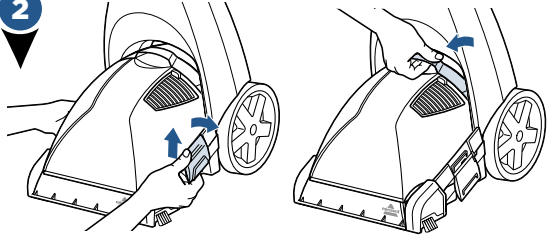

Remove both the Clean and Dirty Water Tanks.

3

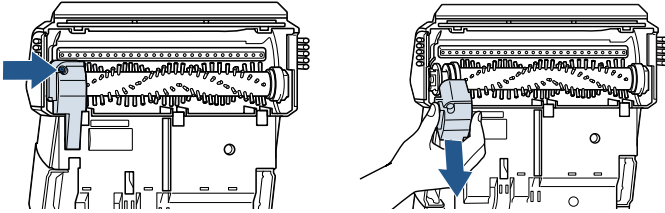

Lay machine down to access the bottom of the machine. With a Phillips-head screwdriver, unscrew the belt cover and remove.

4

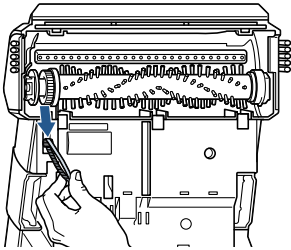

If you want to replace or clean the Brush Roll, remove the belt by slightly lifting the Brush Roll to maneuver the belt and remove it. If the belt is broken and needs to be replaced, remove it and replace with a new belt.

5

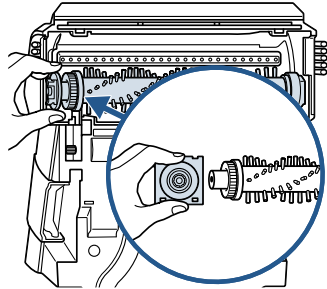

When removing the Brush Roll, the Brush Roll cap will come with it. Do not lose this part.

Replacing the Belts & Brush Rolls (cont.)

7

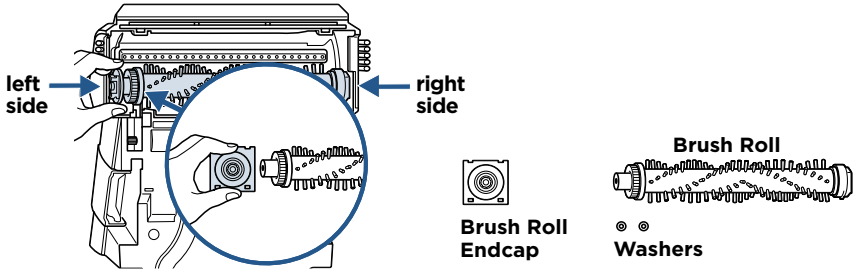

Clean or replace the Brush Roll and belt. When finished, reassemble them to the machine. Insert the brush into the right side endcap. Adjust the right side of the brush into place and tuck the left Brush Roll cap (separate piece that attaches to Brush Roll) into place.

8

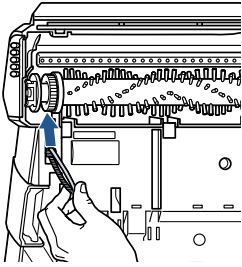

Maneuver the belt to wrap around the pulley. Wrap the belt around the cog of the Brush Roll. Secure the Brush Roll into place by sliding the square piece to align the Brush Roll.

9

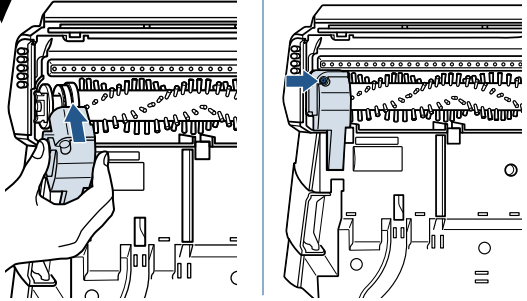

Reattach belt cover and screw into place.

NOTE: Manually rotate brush to make sure it rotates freely and the belt is aligned.

Hard Floor Cleaning (select models only)

WARNING

To reduce the risk of fire and electric shock when cleaning a hard floor, the BISSELL® hard floor tool must be used and it must only be used with BISSELL Wash & Shine Floor Cleaner intended for use with this appliance.

1

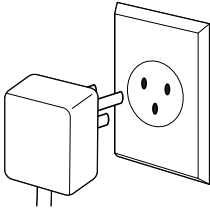

With foot, press the red Power Pedal, to turn OFF machine and then unplug.

2

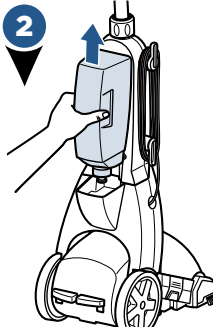

Remove the Clean Water Tank by lifting straight up and away from Lower Body. Fill the tank using water and BISSELL Wash & Shine Floor Cleaner formula for cleaning the hard floor.

3

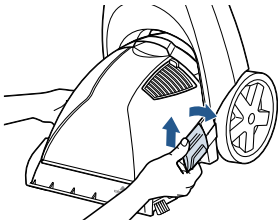

Release Dirty Water Tank Latches (on each side) by pulling up from the bottom of latch and then out.

4

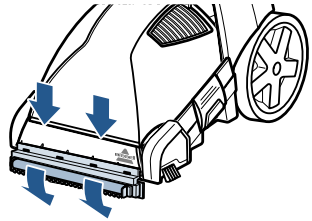

Attach the hard floor tool by hooking it into the front of the nozzle. Rotate down until it snaps into place.

5

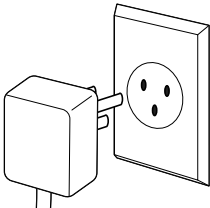

Return both tanks to the machine and plug into a proper outlet.

6

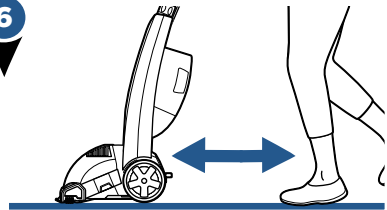

Follow the "Cleaning Pass" instructions on page 8, step 5.

Troubleshooting

WARNING

To reduce the risk of electric shock, turn power OFF and disconnect plug from electrical outlet before performing maintenance or troubleshooting checks.

Problem	Possible causes	Remedies
Reduced spray OR no spray	Clean Water Tank is empty.	Refill tank with water and formula.
	Lint screen on Clean Water Tank cap clogged.	Soak Clean Water Tank cap in warm water and then rinse under running water.
	Spray nozzle clogged.	Clean spray nozzle by rinsing under water.
	Upper handle is not in the upright and locked position.	Rotate the Collapsible Handle Lock, pull handle up and return the handle lock to the locked position.
	Clean Water Tank not properly seated on machine.	Remove tank, ensure cap is tightened properly, and reinstall tank until you hear a "click".
	Upper handle assembly not fully installed.	Unscrew and reassemble upper handle body to lower base to ensure both assembly screws are fully-seated. Ensure trigger on handle has tension.
Carpet washer not picking up cleaning solution	Dirty Water Tank is not aligned/secured.	Check tank alignment and secure with side latches.
	Dirty Water Tank is full.	Empty tank.
	Removable Nozzle installed improperly.	Unplug machine and align two "hooks" into bottom first, then snap into place on top.
	Removable Nozzle full of debris.	Unplug machine, remove nozzle and rinse under running water.
	Red lint screen under Dirty Water Tank is clogged.	Remove debris from lint screen.

Notes

Consumer Guarantee

This guarantee gives you specific legal rights, in addition to rights you may have under the Australian Consumer Law. If you need additional instruction regarding this guarantee or have questions regarding what it may cover, please contact your local BISSELL® Consumer Services on the details set out below.

Limited 2 Year Guarantee (from the date of purchase by original purchaser)

Subject to the *CONDITIONS identified below, BISSELL will repair or replace (with new, refurbished, lightly used, or remanufactured components or products), at BISSELL's option, free of charge, any defective or malfunctioning part due to manufacturer defect. This guarantee applies to product used for personal purposes, and not commercial or rental service. This guarantee does not apply to fans or routine maintenance or consumable components such as filters, belts, brush rolls, etc., damage or malfunction caused by negligence, abuse, neglect, unauthorized repair, or any other use not in accordance with the user guide. BISSELL recommends that the original packaging be kept for the duration of the guarantee period in case such need arises within the guarantee period that the item needs re-packing and transportation.

It may be necessary to obtain some of your personal information, such as a mailing address, to fulfill terms of this guarantee. Any personal data will be handled pursuant to BISSELL's Privacy Policy, which can be found at BISSELL.com.

*CONDITIONS OF THE GUARANTEE

Subject to whether such loss is reasonably foreseeable, BISSELL and its in-country distributors are not liable for incidental or consequential damages of any nature associated with the use of this product.

FOR AUSTRALIAN CONSUMERS ONLY:

OUR GOODS COME WITH GUARANTEES THAT CANNOT BE EXCLUDED UNDER THE AUSTRALIAN CONSUMER LAW. YOU ARE ENTITLED TO A REPLACEMENT OR REFUND FOR A MAJOR FAILURE AND FOR COMPENSATION FOR ANY OTHER REASONABLY FORESEEABLE LOSS OR DAMAGE. YOU ARE ALSO ENTITLED TO HAVE THE GOODS REPAIRED OR REPLACED IF THE GOODS FAIL TO BE OF ACCEPTABLE QUALITY AND THE FAILURE DOES NOT AMOUNT TO A MAJOR FAILURE.

THIS GUARANTEE IS IN ADDITION TO OTHER RIGHTS OR REMEDIES UNDER LAW. NOTHING IN THIS GUARANTEE EXCLUDES, LIMITS OR MODIFIES ANY LIABILITY OF BISSELL WHICH IS IMPOSED BY LAW, OR LIMITS OR MODIFIES ANY REMEDY AVAILABLE TO THE CONSUMER WHICH IS GRANTED BY LAW. TO MAKE A CLAIM UNDER THIS GUARANTEE CONTACT BISSELL AUSTRALIA PTY LTD (DETAILS BELOW). CONTACT BISSELL PRIOR TO RETURNING ANY GOODS. WHERE AGREED, BISSELL WILL REIMBURSE REASONABLE POSTAGE / HANDLING COSTS (IF ANY) FOR RETURNING GOODS TO BISSELL. TO CLAIM EXPENSES INCURRED IN MAKING A CLAIM UNDER THIS GUARANTEE PLEASE PROVIDE BISSELL WITH A COPY OF THE RECEIPT OF THE EXPENSES BY EMAIL OR POST.

Consumer Care

If your BISSELL® product should require service or to claim under our limited guarantee, please contact us as follows:

Website and Email:

www.BISSELL.com.au
www.BISSELL.co.nz

Telephone:

Australia: 1300-247-735
New Zealand: 0800-247-735

Write:

BISSELL AUSTRALIA PTY LIMITED
42 Rocco Dr.
Scoresby 3179
Victoria
Australia

Replacement parts and accessories are available for purchase.
To purchase visit BISSELL.com.

Visit the BISSELL website: BISSELL.com

When contacting BISSELL, have model number of cleaner available.

Please record your Model Number: _____

Please record your Purchase Date: _____

NOTE: Please keep your original sales receipt. It provides proof of the date of purchase in the event of a guarantee claim. See guarantee for details.



©2020 BISSELL Inc.
All rights reserved. Printed in China
Part Number 1623135 02/20 RevB