

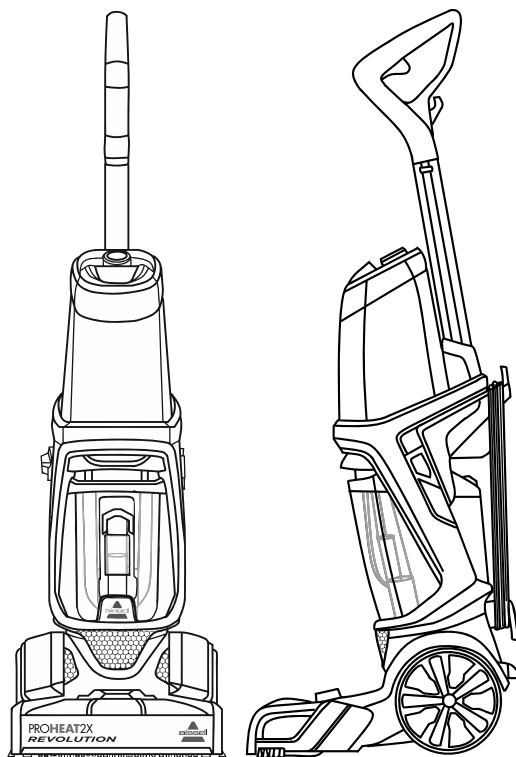

PROHEAT[®] 2X REVOLUTION[®]

Carpet & Upholstery Cleaner

USER GUIDE
1858F



IMPORTANT SAFETY INSTRUCTIONS

READ ALL INSTRUCTIONS BEFORE USING YOUR APPLIANCE.

When using an electrical appliance, basic precautions should be observed, including the following:



WARNING

TO REDUCE THE RISK OF FIRE, ELECTRIC SHOCK OR INJURY:

- » This appliance is not intended for use by persons (including children) with reduced physical, sensory or mental capabilities, or lack of experience and knowledge, unless they have been given supervision or instruction concerning use of the appliance by a person responsible for their safety.
- » Children should be supervised to ensure that they do not play with the appliance.
- » Unplug from electrical socket when not in use, before cleaning, maintaining, or servicing the appliance, and if your appliance has an accessory tool with a moving brush, before connecting or disconnecting the tool.
- » Do not immerse in water or liquid.
- » Keep hair, loose clothing, fingers, and all parts of body away from openings and moving parts of the appliance and its accessories.
- » If the supply cable is damaged, it must be replaced by the manufacturer, its service agent or similarly qualified person in order to avoid a hazard.
- » Do not run appliance over cable.
- » Do not use with damaged cable or plug.
- » Do not pull or carry by cable, use cable as a handle, close door on cable, or pull cable around sharp edges or corners.
- » Keep cable away from heated surfaces.
- » If the appliance has a hand-held accessory like a pet brush, motor driven head, etc., the user shall avoid entrapment.
- » Do not leave appliance when plugged in.
- » To unplug, grasp the plug, not the cable.
- » Do not handle plug or appliance with wet hands.
- » Turn OFF all controls before unplugging.
- » Plastic film can be dangerous. To avoid danger of suffocation, keep away from children.
- » Use only as described in this user guide.
- » Use only manufacturer's recommended attachments.
- » If appliance is not working as it should, has been dropped, damaged, left outdoors, or dropped into water; do not attempt to operate it and have it repaired at an authorised service center.
- » Do not put any object into openings.
- » Do not use with any opening blocked; keep free of dust, lint, hair, and anything that may reduce air flow.
- » Use extra care when cleaning on stairs.
- » Do not use to pick up flammable or combustible liquids, such as petroleum, or use in areas where they may be present.
- » Do not pick up toxic material (chlorine bleach, ammonia, drain cleaner, etc.).
- » Do not use appliance in an enclosed space filled with vapours given off by oil-based paint, paint thinner, some moth-proofing substances, flammable dust, or other explosive or toxic vapours.
- » Do not pick up hard or sharp objects such as glass, nails, screws, coins, etc.
- » Do not pick up anything that is burning or smoking, such as cigarettes, matches or hot ashes.
- » Do not use without filters in place.
- » Use indoors only.

SAVE THESE INSTRUCTIONS

ORIGINAL INSTRUCTIONS. FOR OPERATION ON A 220-240 VOLT A.C. 50-60 HZ POWER SUPPLY ONLY.

THIS MODEL IS FOR HOUSEHOLD USE ONLY.

IMPORTANT INFORMATION

- » Keep appliance on a level surface.
- » If your appliance has a motorised Brush Roll, do not leave machine running in the same spot without the handle fully upright.
- » To reduce the risk of a leaking condition, do not store unit where freezing may occur. Damage to internal components may result.

Thanks for buying a BISSELL deep cleaner!

We love to clean and we're excited to share one of our innovative products with you. We want your deep cleaner to work like new for the years to come, so this guide has tips on how to use, maintain and, if there's a problem, troubleshoot.

Your deep cleaner needs a little assembly before getting to work, so flip to the "assembly" section and let's get started!

What's In The Box?

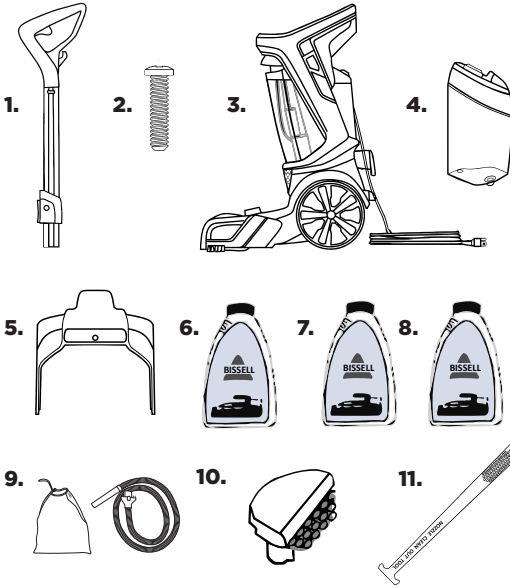

1. Upper Handle
2. (1) Screw attached to Upper Handle
3. Base with Dirty Water Tank
4. Clean Water Tank
5. Carry Handle
6. BISSELL® Wash & Protect Pro
7. BISSELL Wash & Remove Antibacterial
8. BISSELL Oxy Boost Formula
9. Accessory Bag & Hose
10. Attachments/Accessories (vary by model)
11. Nozzle Clean Out Tool

NOTE: Not all accessories come with every model. Be sure to check the carton for additional tools.

Safety Instructions.....	2	Maintenance & Care	11-15
Product View.....	4	Troubleshooting	15
Assembly	5	Guarantee.....	16
Cleaning Formulas.....	6	Service.....	16
Operations	7-10	Contact Information	16

Getting to Know Your Deep Cleaner

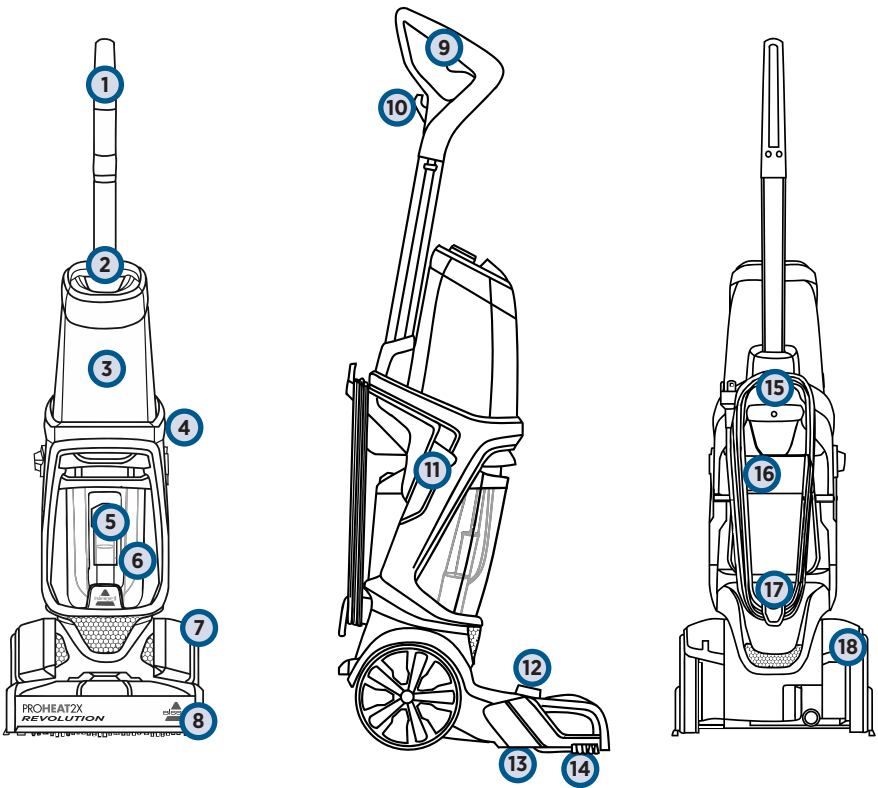

- | | | | |
|----|--|----|-------------------------------------|
| 1 | Upper Handle | 11 | Cleaning Mode Switch |
| 2 | Easy Fill/Formula Cap | 12 | Accessory Hose Door |
| 3 | Clean Water Tank
(3.7 Litre Capacity) | 13 | Belt/Brush Access Plate |
| 4 | Power Switch | 14 | EdgeSweep Brushes |
| 5 | Float Stack | 15 | Carry Handle |
| 6 | Dirty Water Tank | 16 | Rubber Tab
(on Dirty Water Tank) |
| 7 | Belt Access Door | 17 | Cable Quick Release |
| 8 | Foot | 18 | Recline Pedal |
| 9 | Spray Trigger | | |
| 10 | Power Cable Clip | | |

Assembly

WARNING

Do not plug in your deep cleaner until you are familiar with all instructions and operating procedures.

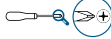
In step 3, you will need to use a Phillips-head screwdriver. 

1

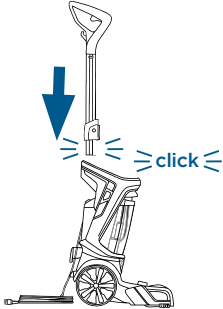

First, insert the Upper Handle at the top of the base until you hear a “click”.

2

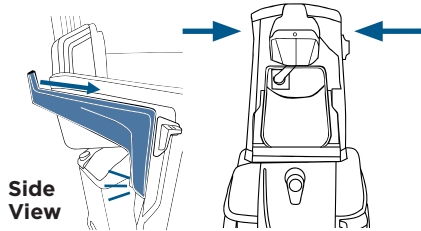

Next, align the Carry Handle with the slots on either side of the base (behind the Power Switch and Cleaning Mode Switch). The Carry Handle will “click” into place.

IMPORTANT: Do NOT put the Clean Water Tank on the machine until step 5.

3



Using a Phillips-head screwdriver, secure the Carry Handle with the screw that's taped to the Upper Handle.

4

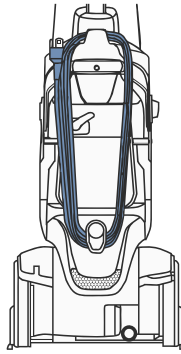

Wrap the cable around the Carry Handle and Cable Quick Release.

5

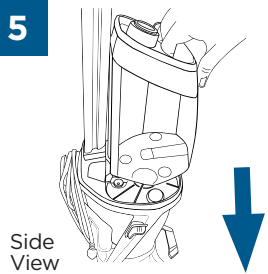

At the bottom of the Upper Handle, align the Clean Water Tank with the grooves and slide the tank into place.

Cleaning Formulas

⚠️ WARNING

To reduce the risk of fire and electric shock due to internal component damage, use only BISSELL® cleaning fluids intended for use with the deep cleaner.

Keep plenty of genuine BISSELL formula on hand so you can clean whenever it fits your schedule. Always use genuine BISSELL deep cleaning formulas. Non-BISSELL cleaning formulas may harm the machine and may void the guarantee.

BOOST CARPET CLEANING FORMULA ENHANCER	PRETREAT PRETREAT SPOTS AND STAINS TO IMPROVE CARPET CLEANING PERFORMANCE		easy fill SYSTEM
			
Oxy Boost	Stain Pretreat	Pet Stain Pretreat	+ Antibacterial
Removes old, set-in stains permanently	Pretreat to penetrate and loosen tough stains	Pretreat to help remove tough pet stains and odors	Cleans and kills odour causing bacteria

2X* CLEANING FORMULA

WASH & PROTECT			WASH & REFRESH			WASH & SHINE
						
Professional Stain & Odour	Pet Stain & Odour	Stain & Odour	Febreze™ Blossom & Breeze	Febreze Cotton Fresh	Natural Orange	Hard Floor Cleaner
Professional strength to remove extra tough stains and odours <i>Includes Scotchgard™ Protector</i>	Removes tough pet stains and contains patented odour removal technology <i>Includes Scotchgard Protector</i>	Removes tough stains and odours <i>Includes Scotchgard™ Protector</i>	Powerful cleaning with a refreshing spring scent	Powerful cleaning with a refreshing clean scent	Powerful cleaning with a refreshing natural orange scent	Removes tough dirt and grime, leaves a natural shine

ONLY BISSELL Wash & Protect formulas protect from future stains with Scotchgard Protector. Scotchgard is a trademark of 3M.

*60 mL of 2X concentrated formula is equivalent to 120 mL of non-concentrated formula.

Certain trademarks used under license from The Procter & Gamble Company or its affiliates

Helpful Cleaning Tips

Before Cleaning

- » Clean on a day with low humidity so carpet dries faster.
- » Consider moving furniture to another area.
- » Vacuum dirt and debris.
- » Pre-treat stains with BISSELL® Pretreat.

While Cleaning

- » Turn on fans and make sure room is ventilated.
- » Dry strokes help carpet dry faster except when using Express Clean Mode or DeepClean + Antibacterial formula (follow directions exactly in those two cases).

After Cleaning

- » Point portable fan at carpet. A dehumidifier may also help in drying.
- » In the winter, turn heat up a few degrees and in the summer, turn the air conditioning down.
- » On warm, dry days, opening the windows is an eco-friendly way to dry.
- » When carpet feels dry, return furniture and put wax paper or aluminum foil underneath. Remove after 3 hours.

Filling Your Clean Water Tank: Wash & Remove + Antibacterial Formula

1



Clean Water Tank (3.7 Litre)

Dirty Water Tank

The Clean Water Tank is at the top of the machine.

2

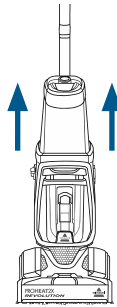

Lift the Clean Water Tank straight up to remove from the machine.

3



Unscrew the cap from the Clean Water Tank. Add warm tap water to the water fill line.

4

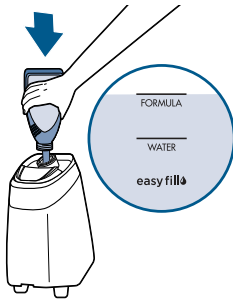

Included Trial Size Antibacterial Formula:

Pour formula into the tank up to the EasyFill line. Twist cap back on to tank.

5

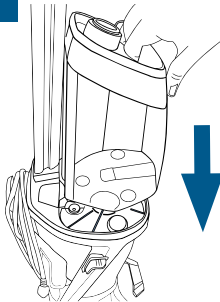

At the bottom of the Upper Handle, align the Clean Water Tank with the grooves and slide the tank into place.

For Future Use with Full Size Antibacterial Formula:

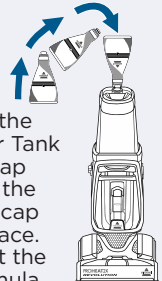

After filling the Clean Water Tank with warm tap water, twist the yellow tank cap back into place. Firmly insert the full size formula bottle into the cap on the Clean Water Tank and squeeze until formula reaches the EasyFill line.

A few notes about filling the Clean Water Tank:

- Fill with warm (140°F/60°C MAX) tap water and add the appropriate BISSELL® solution. **DO NOT USE BOILING WATER. DO NOT HEAT WATER OR TANK IN MICROWAVE.**
- When using BISSELL Wash & Remove + Antibacterial formula: Only fill your Clean Water Tank with the recommended amount of water and formula to achieve anti-bacterial benefits.

NOTICE: Do not overwet carpet. Be careful not to run over loose objects or edges of area rugs. Stalling the brush may result in premature belt failure.

Filling Your Clean Water Tank: 2X Concentrated Formula

1

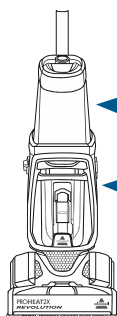

Clean Water Tank
(3.7 Litre)

Dirty Water Tank

The Clean Water Tank is at the top of the machine.

2

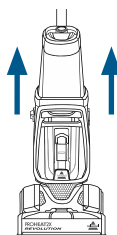

Lift the Clean Water Tank straight up to remove from the machine.

3

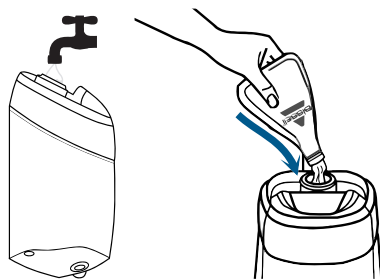

Unscrew the cap from the Clean Water Tank. Add warm tap water to the water fill line. Next, reference the chart below for formula addition to the tank. After formula is added, secure the tank cap in place.

4

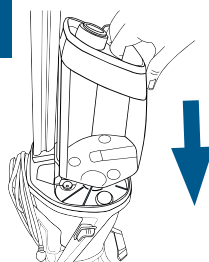

At the bottom of the Upper Handle, align the Clean Water Tank with the grooves and slide the tank into place.

FORMULA FILLING INSTRUCTIONS

DEEP CLEAN MODE

EXPRESS CLEAN MODE

BISSELL® 2X Concentrated Formulas

Fill water to the Water Fill Line, then add 74 mL of formula.

Fill water to the Water Fill Line, then add 37 mL of formula.

NOTE: Fill with warm (140°F/60°C MAX) tap water and add the appropriate BISSELL solution. **DO NOT USE BOILING WATER. DO NOT HEAT WATER OR TANK IN MICROWAVE.** Do not substitute BISSELL 2X Formula cleaning solution with other household cleaning products.



Pour in more power with BISSELL Oxy Boost

- Fill tank with water and 2X formula (Step 3 above).
- Add 60 mL of BISSELL Oxy Boost per 3.7 L of water.
- The ProHeat® 2X Revolution® has a 3.7 L Clean Water Tank.

NOTICE: Do not overwet carpet. Be careful not to run over loose objects or edges of area rugs. Stalling the brush may result in premature belt failure.

Cleaning Your Carpet

1

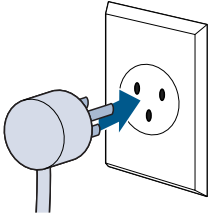

Plug into a properly earthed outlet.

2

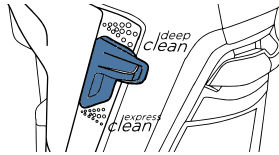

Select Cleaning Mode:

Deep Clean: Delivers a deep clean to your carpet.

Dry Time: About 8 hours

Express Clean: Provides a lighter clean.

Dry Time: Less than 30 minutes

*Choose "Deep Clean" mode and use BISSELL Wash & Remove + Antibacterial to deliver antibacterial benefits.

3

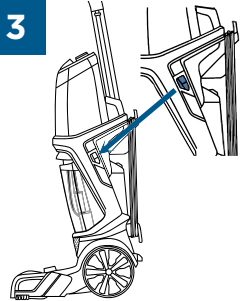

Press the Power Switch to turn the machine ON. To recline your machine for use, press the Recline Pedal with your foot.

4

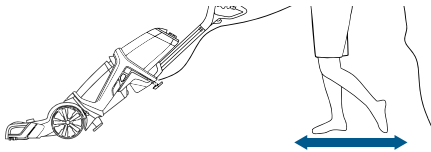

Deep Clean Mode:

Standard Cleaning

1. Press the Spray Trigger to apply solution while making 2 slow, wet passes (1 forward, 1 back).
2. Release the Spray Trigger.
3. Make 2 slow, dry passes (1 forward, 1 back) to suck up the dirty solution. **Do not hold down the trigger for this step.**

Using BISSELL® Deep Clean + Antibacterial Formula

1. Press the Spray Trigger to apply solution while making 3 slow, wet passes (1 forward, 1 back, and 1 forward again).
2. Release the trigger.
3. Make 1 slow, dry pass back to suck up the dirty solution. **Do not hold down the trigger for this step.**

Express Clean Mode:

Recommended Cleaning Pace: 30.5cm/s

1. Press the Spray Trigger to apply solution while making 2 wet passes (1 forward, 1 back).
2. Release the Spray Trigger.
3. Make 2 dry passes (1 forward, 1 back) to suck up the dirty solution. **Do not hold down the trigger for this step.**

NOTICE: To prevent damage to Berber carpets, avoid repeated strokes in the same area.

Cleaning Area Rugs

IMPORTANT: Please check manufacturer's tag before cleaning area rugs for any specialized cleaning instructions. We do not recommend deep cleaning delicate, silk, wool, antique, or area rugs without a manufacturer's tag.

Regularly clean your high-traffic area rugs in Express Clean Mode:

- » Check the manufacturer's tag.
- » Select Express Clean Mode.
- » When cleaning area rugs, place the rug on a sealed surface to test for colorfastness in an inconspicuous area. Your cleaner should not be used on unsealed surfaces.
- » Important: Keep the foot of the deep cleaner perpendicular to the rug's edge with each cleaning pass to prevent damage.

Cleaning with Hose and Tool

- » **Keep hair, loose clothing, fingers, and all parts of body away from openings and moving parts.**
- » **The Brush Roll continues to turn while product is turned on and handle is in upright position. To avoid damage to carpet, rugs, furniture, and flooring, avoid tipping cleaner or setting it on furniture, fringed area rugs or carpeted stairs during tool use.**
- » **With Brush Roll on, do not allow cleaner to sit in one location for an extended period of time, as damage to floor can result.**

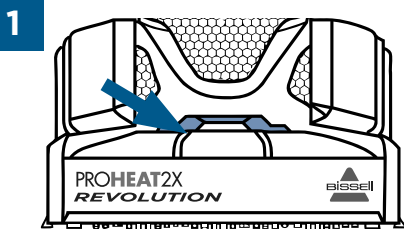

Lift the Accessory Hose Door on top of foot on the front of the machine. The door flips toward the machine to open.

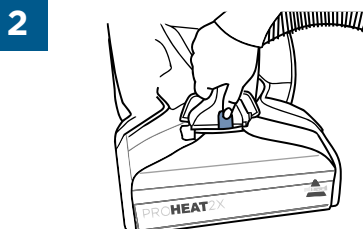

Insert the hose and snap into place. Be sure the colored hose release clip is facing out, away from machine.

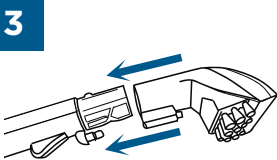

Attach the tool to the end of the hose. (Tools may vary by model.) Press the Power Switch to turn machine ON.

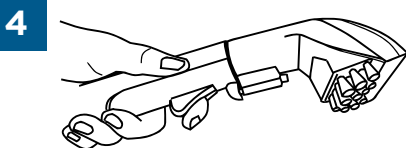

Press the Spray Trigger button to spray the soiled area, then slowly move tool back and forth over the area.

Release the trigger to suck up the dirty solution. Work in small sections until the area is clean.

When finished cleaning, turn the machine ON to suction up warm clean water to rinse the inside of the hose and tool. Detach the hose and tool and close the Accessory Hose Door. Let the hose and tool air dry before storing.

Emptying the Dirty Water Tank

WARNING

To reduce the risk of fire, electric shock or injury, turn power OFF and disconnect plug from electrical outlet before performing maintenance or troubleshooting.

1

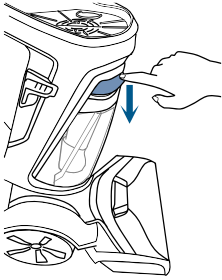

To release Dirty Water Tank, press down on the colored tank Handle.

2

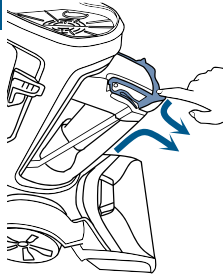

Tilt the tank slightly toward you. Grab the handle and tank with both hands.

3

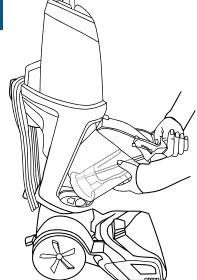

Pull Dirty Water Tank up and away to remove.

4



For quick empty:

Pull the rubber tab (located in the middle of the tank) and tilt to pour.

When closing the rubber tab, make sure all edges are sealed tight.

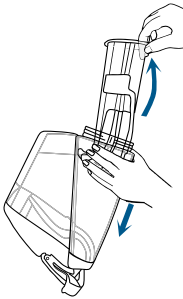

For final clean and rinse:

Unscrew the ring at the bottom of tank.

Gently remove the Float Stack, rinse, and clean.

Once clean, return Float Stack into the tank by lining up the arrows so they point at each other. This is the only way the Float Stack will fit into the tank.

With the arrows aligned, the Float Stack should lock into place.

Return the ring and twist to lock. Water may leak if the ring is not fully tightened.

5

Clean the red filter below the Dirty Water Tank by wiping off any remaining dirt or debris.

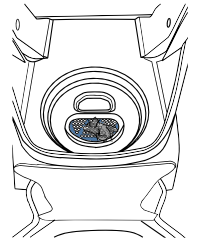

6

To return the Dirty Water Tank:

Angle the tank and insert bottom first. Then tilt the tank toward the machine and push the top in until it clicks into place.

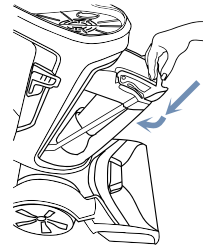

Did You Know?

The Float Stack is what prevents your Dirty Water Tank from overflowing.

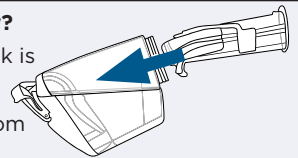

Cleaning Machine After Use

⚠️ WARNING To reduce the risk of fire, electric shock or injury, turn power OFF and disconnect plug from electrical outlet before performing maintenance or troubleshooting.

1

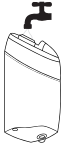

Rinse the Clean Water Tank with warm tap water. Fill the tank with warm tap water, twist the cap on and return the tank to the machine.

2

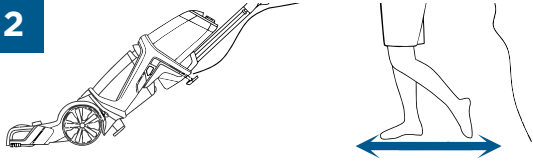

To flush and rinse machine turn it ON and press the Spray Trigger for 15 seconds while making forward and backward passes on carpet. Release the trigger and suck up water. Empty both tanks and let dry before storing. Wipe the machine's exterior with a soft cloth.

Cleaning the Brush Rolls

1

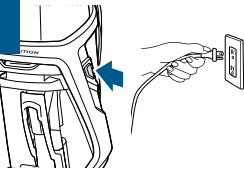

Turn OFF and unplug the machine.

2

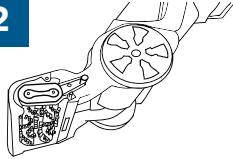

Lay the machine down on its back or side.

3

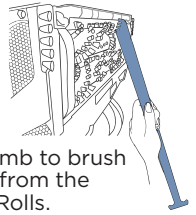

Use comb to brush debris from the Brush Rolls.

Cleaning the Nozzle

1

If pet hair or debris gets clogged in the nozzle, turn OFF and unplug the machine and use the Nozzle Clean Out Tool.

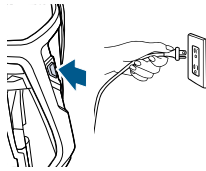

2

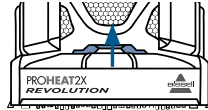

Remove the nozzle from the foot by opening the Accessory Hose Door and lifting the nozzle up and away from the foot.

3

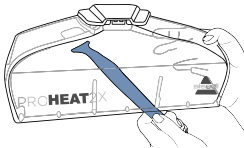

Hold the nozzle and insert the tool into the thin slot on the bottom of the nozzle that touches the floor. Move the tool around in multiple directions to clean.

4

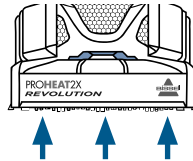

Replace the nozzle by lining up the three hooks on the nozzle to the bottom of the foot. Rotate it up and click into place. Close the Accessory Hose Door.

Replacing Belts & Brush Roll

What you will need: 1 Phillips-head screwdriver & 1 flat-head screwdriver.

1

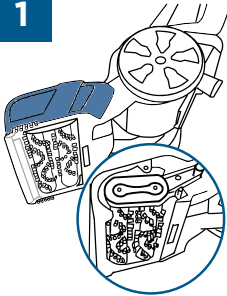

Remove Clean Water Tank and make sure the Dirty Water Tank is empty. Press the Recline Pedal and lay the machine on its side. Remove 3 screws on the belt/brush access plate using a Phillips-head screwdriver. Remove the plate to expose the belt.

2

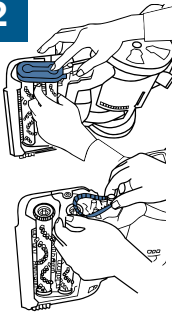

Brush Roll & Small Belt Replacement

Remove the brush cover by lifting it up, then lift the small belt to remove. The Brush Rolls can be gently removed and replaced with new Brush Rolls. (Skip to step 7 for small belt replacement.)

3

Large Wheel Belt Replacement

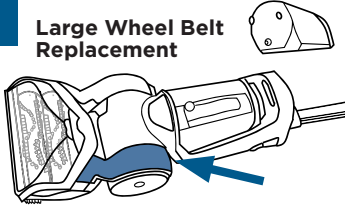

Make sure to press the Recline Pedal and lay the machine on its back. Use a flat-head screwdriver to help lift the Belt Access Door and remove. If the belt is not broken, skip to step 8.

4

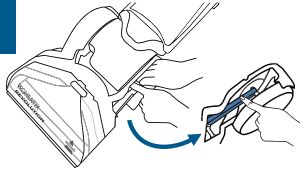

If the belt is broken, gently remove it from the machine.

5

To replace the large belt, place it over the red area of the large pulley near the front of the machine.

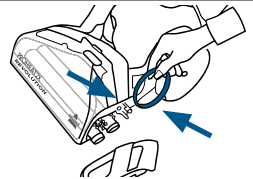

6

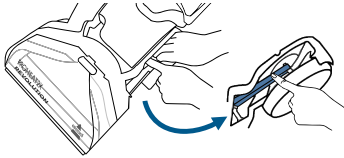

Stretch the belt towards the back of the machine with your thumb and transfer it onto the metal axle. Snap the Belt Access Door back into place.

7

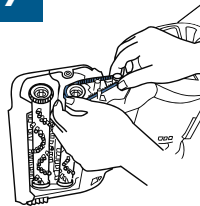

Replace smaller toothed belt by wrapping around the small metal toothed pulley and the gear at the end of the rear-most brush.

8

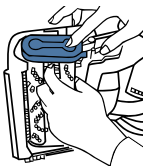

Replace and secure the brush roll cover, making sure Brush Rolls are aligned.

NOTE: It is important the Brush Rolls align on both ends of the foot.

9



Return Belt/Brush Access Plate to the end of the Brush Rolls. It will "click" in place when screws align. Use a screwdriver to secure the plate with the three screws.

NOTE: Force must be used to lift the Belt Access Door. There is a small belt and end cap on the other end of the Brush Rolls. That belt needs to wrap around the tooth end of the Brush Rolls and the end cap needs to be secure before re-assembling the machine.

Replacing Belts or Brush Rolls

What you will need: 1 Phillips-head screwdriver & 1 flat-head screwdriver

1

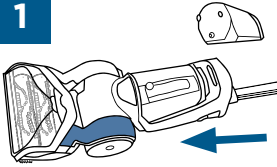

Unplug the machine. Remove both tanks from the machine. Press the Recline Pedal and lay the machine on its back. Use a flat-head screwdriver to help lift and remove the Belt Access Door.

2

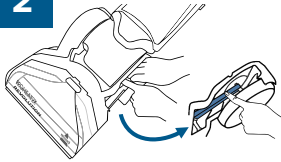

Here you should see one (1) belt. This is the Flat Pump Belt. If the Flat Pump Belt is broken, gently remove it from the machine. We will replace this belt in Step 5.

3

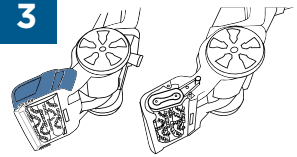

Turn the machine on its side. The Power Switch should be facing up. Remove the 3 screws on the Belt/Brush Access Plate using a Phillips-head screwdriver. Remove the Access Plate to expose the Brush Cover and Cogged Large Pump Belt.

4

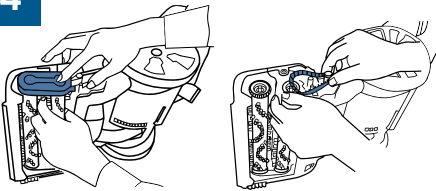

Remove the Brush Cover by lifting straight up. Remove the Cogged Large Pump Belt. The Brush Rolls can be replaced or cleaned at this time, if needed.

5

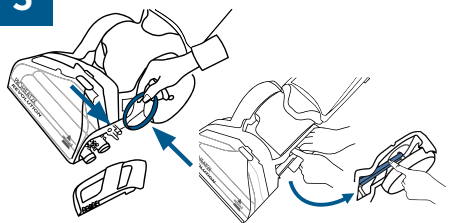

Now, if the Flat Pump Belt was broken, place a new Flat Pump Belt around the red area of the large pulley. Then use your thumb to stretch it toward the back of the machine and transfer it onto the metal axle.

6

Spin either brush. If they both spin continue to Step 7.

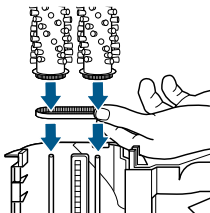

If only one spins, the opposite belt is broken and you must remove both brushes and replace the Small Cogged Brush Belt.

Place the new belt around both brush gears and slide them onto the thin metal axles.

7

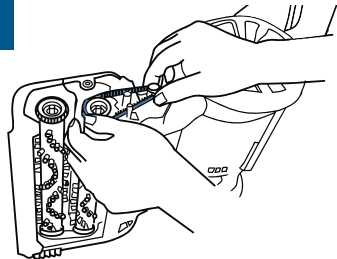

To replace the Cogged Large Pump Belt, make sure your deep cleaner is completely reclined. Begin by wrapping the Cogged Large Pump Belt around the small metal-toothed pulley. While wrapped around the pulley, stretch and wrap around the nearest brush gear.

Replacing Belts or Brush Rolls (cont.)

8

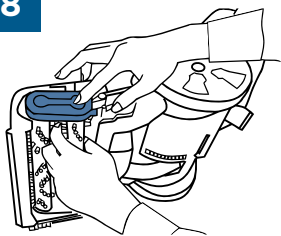

Return the Brush Cover. Make sure that the brushes are aligned and the cover is secure.

9

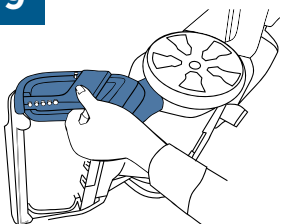

Return the Belt/Brush Access Plate to the end of the Brush Rolls by securing with the 3 screws.

10

Turn the machine to lay on its back.

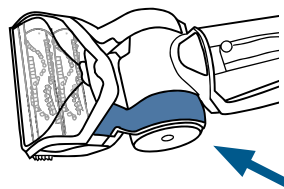

Lastly, slide the Belt Access Door back into place. You should hear it "click" into place.

Troubleshooting

WARNING

To reduce the risk of fire, electric shock or injury, turn power OFF and disconnect plug from electrical outlet before performing maintenance or troubleshooting.

Problem	Possible causes	Remedies
Reduced spray OR no spray	Clean Water Tank may be empty.	Refill tank.
	Clean Water Tank may not be seated completely.	Turn power OFF. Remove and reseat tank.
	Pump may have lost prime in hose cleaning mode.	Hold end of hose below water level in tank to prime.
Loss of suction power	Tanks may not be seated properly.	Pick up both tanks and reseat them so they fit properly on the unit.
	Dirty Water Tank has picked up maximum amount of dirty water and has reached full line.	Empty tank.
	Clean Water Tank is empty.	Check fluid levels in the Clean Water Tank. Refill the tank if it is empty.
	Rubber tab on Dirty Water Tank is not sealed tight.	Check the rubber tab on the Dirty Water Tank and press firmly on all edges to secure it tightly (see step 4 on page 12 for detail).
	Accessory hose door may not be closed tightly in place.	Check the accessory hose door and make sure it is closed tightly by pushing down to lock into place.
	Nozzle may be clogged from pet hair or debris.	Use the Nozzle Clean Out Tool and follow steps on page 12 for "Cleaning the Nozzle".

Consumer Guarantee

This guarantee gives you specific legal rights, in addition to rights you may have under the Australian Consumer Law. If you need additional instruction regarding this guarantee or have questions regarding what it may cover, please contact your local BISSELL Consumer Services on the details set out below.

Limited 2 Year Guarantee (from the date of purchase by original purchaser)

Subject to the *CONDITIONS identified below, BISSELL will repair or replace (with new, refurbished, lightly used, or remanufactured components or products), at BISSELL's option, free of charge, any defective or malfunctioning part due to manufacturer defect. This guarantee applies to product used for personal purposes, and not commercial or rental service. This guarantee does not apply to fans or routine maintenance or consumable components such as filters, belts, Brush Rolls, etc., damage or malfunction caused by negligence, abuse, neglect, unauthorized repair, or any other use not in accordance with the user guide. BISSELL recommends that the original packaging be kept for the duration of the guarantee period in case such need arises within the guarantee period that the item needs re-packing and transportation.

It may be necessary to obtain some of your personal information, such as a mailing address, to fulfill terms of this guarantee. Any personal data will be handled pursuant to BISSELL's Privacy Policy, which can be found at www.BISSELL.eu.

*CONDITIONS OF THE GUARANTEE

Subject to whether such loss is reasonably foreseeable, BISSELL and its in-country distributors are not liable for incidental or consequential damages of any nature associated with the use of this product.

FOR AUSTRALIAN CONSUMERS ONLY:

OUR GOODS COME WITH GUARANTEES THAT CANNOT BE EXCLUDED UNDER THE AUSTRALIAN CONSUMER LAW. YOU ARE ENTITLED TO A REPLACEMENT OR REFUND FOR A MAJOR FAILURE AND FOR COMPENSATION FOR ANY OTHER REASONABLY FORESEEABLE LOSS OR DAMAGE. YOU ARE ALSO ENTITLED TO HAVE THE GOODS REPAIRED OR REPLACED IF THE GOODS FAIL TO BE OF ACCEPTABLE QUALITY AND THE FAILURE DOES NOT AMOUNT TO A MAJOR FAILURE.

THIS GUARANTEE IS IN ADDITION TO OTHER RIGHTS OR REMEDIES UNDER LAW. NOTHING IN THIS GUARANTEE EXCLUDES, LIMITS OR MODIFIES ANY LIABILITY OF BISSELL WHICH IS IMPOSED BY LAW, OR LIMITS OR MODIFIES ANY REMEDY AVAILABLE TO THE CONSUMER WHICH IS GRANTED BY LAW. TO MAKE A CLAIM UNDER THIS GUARANTEE CONTACT BISSELL AUSTRALIA PTY LTD (DETAILS BELOW). CONTACT BISSELL PRIOR TO RETURNING ANY GOODS. WHERE AGREED, BISSELL WILL REIMBURSE REASONABLE POSTAGE / HANDLING COSTS (IF ANY) FOR RETURNING GOODS TO BISSELL. TO CLAIM EXPENSES INCURRED IN MAKING A CLAIM UNDER THIS GUARANTEE PLEASE PROVIDE BISSELL WITH A COPY OF THE RECEIPT OF THE EXPENSES BY EMAIL OR POST.

Consumer Care

If your BISSELL® product should require service or to claim under our limited guarantee, please contact us as follows:

Website and Email:

www.BISSELL.com.au
www.bissell.co.nz

Telephone:

Australia: 1300-247-735

New Zealand: 0800-247-735

Replacement parts and accessories are available for purchase.
To purchase visit www.BISSELL.com.au.

Write:

BISSELL AUSTRALIA PTY LIMITED
42 Rocco Dr.
Scoresby 3179
Victoria
Australia

Visit the BISSELL website: www.BISSELL.com.au

When contacting BISSELL, have model number of cleaner available.

Please record your Model Number: _____

Please record your Purchase Date: _____

NOTE: Please keep your original sales receipt. It provides proof of the date of purchase in the event of a Guarantee claim. See Guarantee for details.



©2019 BISSELL Homecare, Inc
Grand Rapids, Michigan
All rights reserved. Printed in China
Part Number 161-8335 11/18 RevC
Visit our website at: www.BISSELL.com.au