



SPOTCLEAN™

PORTABLE CARPET & UPHOLSTERY CLEANER

MODELS 3861P, 3861F

Assembly.....	3	Emptying the Dirty Water Tank.....	7
Filling the Formula Tank.....	4	Cleaning and Storing Your Machine.....	8
Using Your Machine.....	5	Limited Warranty.....	9

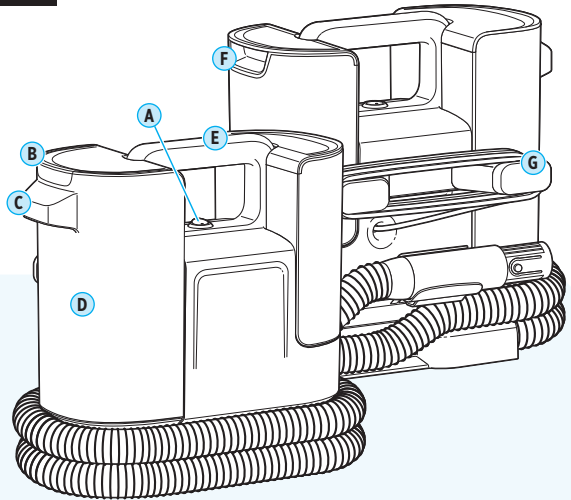

Product Overview

- A. Power Switch
- B. Dirty Tank Lid
- C. Dirty Tank Handle
- D. Dirty Tank (Float Stack inside)
- E. Carry Handle
- F. Clean Tank Handle
- G. Power Cord Wrap

SYMBOL	EXPLANATION
	Caution.
	Read operator's manual.
	Risk of fire.
	Risk of electric shock.
	Do not expose to rain.
	Store indoors.
	Do not overwet carpet. Use only on carpet moistened by the cleaning process.
	Use only BISSELL® cleaning formulas intended for use with this machine.
	Disconnect power before servicing.

SYMBOL	EXPLANATION
	Do not freeze.
	Allow parts to dry.
	Use warm water, temperature up to 60°C.
	Check the manufacturer's tag before cleaning textile. "W" on the tag as shown means you can use your cleaner.
	Lock.
	This symbol on the product and/or accompanying documents means that used electrical and electronic products should not be mixed with general household waste. For proper treatment, recovery and recycling, please take this product to designated collection points. Please contact your local authority for further details of your nearest designated collection point.

IMPORTANT SAFETY INSTRUCTIONS

READ ALL INSTRUCTIONS BEFORE USING YOUR APPLIANCE.

When using an electrical appliance, basic precautions should be observed, including the following:

WARNING TO REDUCE THE RISK OF FIRE, ELECTRIC SHOCK OR INJURY:

- Plastic film can be dangerous. To avoid danger of suffocation, keep away from children.
- Keep hair, loose clothing, fingers, and all parts of body away from openings and moving parts of the appliance and its accessories.
- Floor slippery when wet.
- The plug must be removed from the socket-outlet before cleaning or maintaining the appliance.
- Use only as described in this user guide.
- Use only manufacturer's recommended attachments.
- If appliance is not working as it should, has been dropped, damaged, left outdoors, or dropped into water; do not attempt to operate it and have it repaired at an authorised service center.
- Do not put any object into openings.
- Do not use with any opening blocked; keep free of dust, lint, hair, and anything that may reduce air flow.
- Use extra care when cleaning on stairs.
- Do not use to pick up flammable or combustible liquids, such as petroleum, or use in areas where they may be present.
- Do not pick up anything that is burning or smoking, such as cigarettes, matches or hot ashes.
- Do not pick up toxic material (chlorine bleach, ammonia, drain cleaner, etc.).
- Do not use appliance in an enclosed space filled with vapours given off by oil base paint, paint thinner, some moth-proofing substances, flammable dust, or other explosive or toxic vapours.
- If the supply cable is damaged, it must be replaced by the manufacturer, its service agent or similarly qualified person in order to avoid a hazard.

- Do not pull or carry by cable, use cable as a handle, close door on cable, or pull cable around sharp edges or corners. Keep cable away from heated surfaces.
- Do not leave appliance when plugged in. Unplug from outlet when not in use and before servicing.
- To unplug, grasp the plug, not the cable.
- Do not handle plug or appliance with wet hands.
- Turn off all controls before unplugging.
- Do not expose to rain. Store indoors.
- Always connect to a properly earthed electrical socket. Do not modify earthed plug.
- Liquid must not be directed towards equipment containing electrical components.
- Do not immerse. Use only on surfaces moistened by the cleaning process. Use only BISSELL cleaning products intended for use with this machine.
- Use only the type and amount of liquids specified under the operations section of this guide.
- Prevent unintentional starting. Ensure the switch is in the OFF position before picking up or carrying the appliance. Carrying the appliance with your finger on the switch or energizing appliance that have the switch on invites accidents.
- This appliance is not intended for use by persons (including children) with reduced physical, sensory or mental capabilities, or lack of experience and knowledge, unless they have been given supervision or instruction concerning use of the appliance by a person responsible for their safety. Children shall not play with the appliance. Cleaning and user maintenance shall not be made by children without supervision.
- Do not pick up hard or sharp objects such as glass, nails, screws, coins, etc.

SAVE THESE INSTRUCTIONS

ORIGINAL INSTRUCTIONS. FOR OPERATION ON A 220-240 VOLT A.C. 50-60 HZ POWER SUPPLY ONLY.
THIS MODEL IS FOR HOUSEHOLD USE ONLY.

IMPORTANT INFORMATION

- To reduce the risk of a leaking condition, do not store where freezing may occur. Damage to internal components may result.
- Plastic tanks are not dishwasher safe. Do not put tanks in dishwasher.
- Do not turn ON your appliance until you are familiar with all instructions and operating procedures.

TOOLS INCLUDED IN BOX WILL DIFFER BY MODEL

To see what's included with your purchase,
check the "Carton Contents" list on the top flap of the box.



Machine



Hose Clip



Self-Cleaning
Tough Stain Tool



Trial Cleaning
Solution
(varies by model)



Spraying Crevice Tool
(select models)



3-in-1 Stair Tool
(select models)

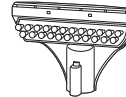

15cm Tool
(select models)

Assembly

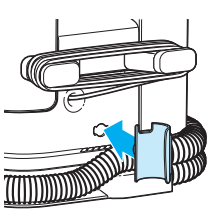

1. To install hose clip, insert into back of machine and rotate clockwise until it clicks.

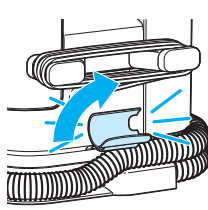

2. Wrap hose around bottom of machine and place on hose clip.

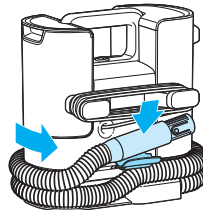

Filling the Formula Tank



This machine is compatible with BISSELL® formulas made for portable carpet cleaners. Always use genuine BISSELL formulas in your machine. Use of other cleaning formulas may harm the machine.

<p>1. Choose your formula.*</p>	<p>2. Lift clean water tank up to remove.</p>	<p>3. Unscrew cap.</p>
<p>4. Based on size of your mess, add water to the appropriate fill line. Small Area: 400 mL Large Area: 800 mL</p>	<p>5. Add formula to the line based on the size of your mess. Small Area: 60 mL Large Area: 120 mL</p>	<p>6. Tighten cap back into place. Align clean tank with groove on machine and slide down until it clicks.</p>

*Compatible BISSELL formulas include: Spot & Stain, Pet Stain & Odour, Oxygen Boost

⚠ WARNING To reduce the risk of fire and electric shock due to internal component damage, use only BISSELL cleaning formula intended for use with this machine.

Using Your Machine



Before You Clean

- Vacuum to remove loose dirt from areas to be cleaned.
- Spray any BISSELL stain pretreat formula on soiled areas and allow to sit for a few minutes.
- Tip: For upholstery, work in small sections until area is clean.

Attaching and Using the Tools

<p>1. Unwrap hose. Attach your desired tool to end of hose grip until it clicks.</p>	<p>2. Unwrap power cord from bracket.</p>	<p>3. Plug into a properly grounded outlet. Press power switch button ON.</p>

<p>4. Point tool above stain, press and hold trigger to mist solution over affected area.</p>	<p>5. Release spray trigger and gently scrub stain using bristles.</p>	<p>6. Apply firm downward pressure with tool and slowly pull it toward you to remove stain. Release trigger and make “dry passes” to remove any remaining moisture. Repeat as needed until no water can be seen in nozzle.</p>

Using the Spraying Crevice Tool (select models)

<p>7. While holding tool above the stained area, press and hold the trigger to spray solution.</p>	<p>8. Release spray trigger and press tool firmly against surface and pull toward you to remove the stain. Repeat this step as needed.</p>

CONTINUED ON NEXT PAGE ➔

Using the Self-Cleaning Tough Stain Tool (select models)

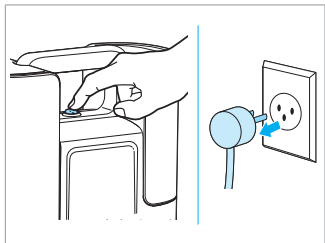
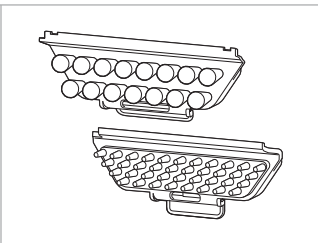
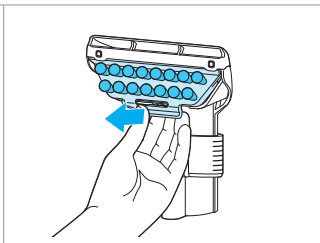
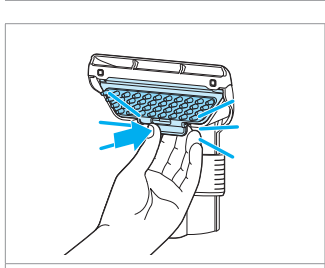
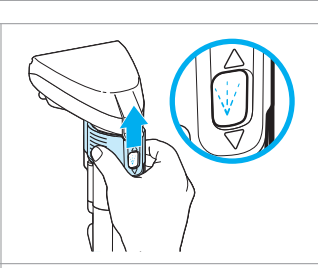
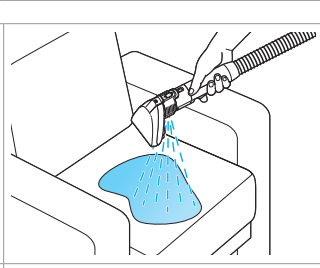
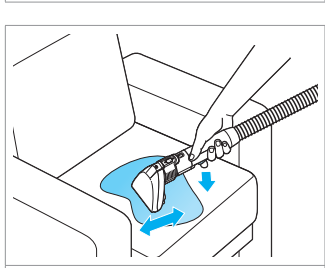
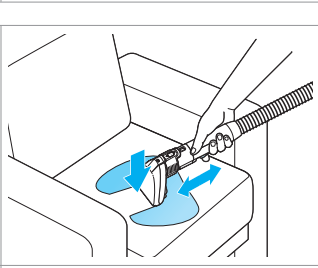
		
<p>1. Turn OFF and unplug machine.</p>	<p>2. Choose your cleaning method: Use the bristle block for everyday soft surface cleaning, or the rubberized block to remove embedded pet hair and debris.</p>	<p>3. Pull bottom latch to release bristle block from tool.</p>
		
<p>4. Insert your preferred tool block; it will click into place.</p>	<p>5. Slide tool lever up to ensure tool is in SPRAY mode. Follow steps 4-6 above to clean.</p>	<p>6. While holding tool above desired area, press and hold trigger to spray solution.</p>
		
<p>7. Release spray trigger and gently scrub stain using bristles.</p>	<p>8. With trigger released, press tool firmly against surface and pull towards you to remove stain. Repeat as needed.</p>	

CONTINUED ON NEXT PAGE ➔

Using the 3-in-1 Stair Tool (select models)

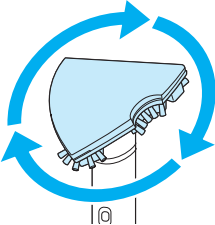
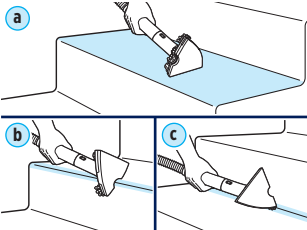
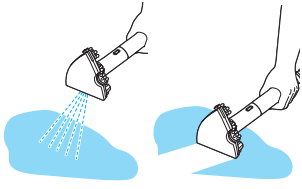
		
<p>1. Twist tool to desired position. The downward facing edge is the active cleaning mode.</p>	<p>2. Use on stairs 3 ways:</p> <ul style="list-style-type: none"> a. Use the flat edge to clean the stair tread. b. Use indented area to clean the outside corner. c. Use pointed edge to clean the crevice. 	<p>3. Point the tool approximately 1 inch above the spot or stain and press the spray trigger. Suction up the stain by placing tool onto carpet and slowly moving backwards.</p>

Emptying the Dirty Water Tank



		
<p>1. Empty tank when water reaches "MAX" line. Do not let water level fill above the MAX line.</p>	<p>2. Turn OFF and unplug machine.</p>	<p>3. Remove dirty water tank by tilting outward and carry to a disposal area. Pull up on dirty tank lid to remove.</p>
		
<p>4. Pour out dirty water and rinse tank.</p>	<p>5. Reinstall tank lid.</p>	<p>6. Insert bottom of tank first and push top of tank toward machine until it clicks into place.</p>

Cleaning and Storing Your Machine



<p>1. Turn OFF and unplug machine.</p>	<p>2. To disconnect tools, push down on button above hose grip and pull straight off. (Do NOT twist tool to remove it.)</p>	<p>3. Select models with Self-Cleaning Tough Stain Tool: Remove tool lens and rinse.</p>

<p>4. Rinse tools under clean, running water. Allow tools to dry.</p>	<p>5. When finished using the product, wrap cord and hose for storage. Store indoors in a dry location where product is not likely to get damaged.</p>	

Cleaning Machine with Self-Cleaning Tough Stain Tool (select models)

<p>1. Turn machine ON. Slide tool lever down for cleanout mode.</p>	<p>2. Press the trigger to activate the CLEANOUT function. Solution mixture will come through the tool and the hose.</p>	<p>3. To continue cleaning with your machine, slide the tool's lever upward to return to spray mode.</p>

Note: Other maintenance or service not included in this manual should be performed by an authorized service representative.

NOTICE: To reduce the risk of a leaking condition, do not store where freezing may occur. Damage to internal components may result. Store machine in protected, dry area at room temperature (4c - 40c).

⚠ WARNING To reduce the risk of fire and electric shock due to internal component damage, use only BISSELL cleaning formula intended for use with this machine.

Limited Warranty

This limited warranty is provided by BISSELL® International Trading Company B.V. ("BISSELL") and applies in Australia and New Zealand. It gives you specific rights. It is offered as an additional benefit to your rights under law. You also have other rights under The Australian Consumer Law or New Zealand Consumer Laws, whichever applies to you. You can find out about your legal rights and remedies by contacting your local consumer advice service. Nothing in this warranty will replace or lessen any of your legal rights or remedies. If you need additional instruction regarding this warranty or have questions regarding what it may cover, please contact BISSELL Consumer Care or contact your local distributor.

This warranty is given to the current owner of the product with the original sales receipt. The original sales receipt must include the product(s) purchased, the date purchased, and which country it was purchased from new. You must be able to evidence the date of purchase and show the product was purchased in Australia or New Zealand to submit a claim under this warranty. You will receive the warranty that is applicable to the country where your product was originally purchased, as shown on the original sales receipt. If you use the product outside of the country where it was purchased, your warranty may be void in BISSELL's sole discretion. It may be necessary to obtain some of your personal information, such as a mailing address, to fulfill the terms of this warranty. Any personal data will be handled pursuant to BISSELL's Privacy Policy, which can be found at global.BISSELL.com/privacy-policy.

Limited 2- or 3-Year Warranty (varies by model)

Model 3861F: Limited 2- year warranty

Model 3861P: Limited 3- year warranty

For two or three from the date of purchase by the original purchaser, subject to the *EXCEPTIONS AND EXCLUSIONS identified below, BISSELL will repair or replace (with new, refurbished, lightly used, or remanufactured components or products), at BISSELL's option, free of charge, any defective or malfunctioning part or product.

BISSELL recommends that the original packaging and original proof of purchase with the date of purchase and country where purchased be kept for the duration of the warranty period in case you want to redeem the warranty during the warranty period. Keeping the original packaging will assist with any necessary re-packaging and transportation but is not a condition of the warranty.

If your product is replaced by BISSELL under this warranty, then the new item will benefit from the remainder of the term of this warranty (calculated from the date of the original purchase). The period of this warranty shall not be extended whether or not your product is repaired or replaced.

*Conditions of Warranty

This warranty applies to products used for personal domestic use and not commercial or hire purposes. Consumable components and attachments such as filters, belts, shells, water tanks, scraping strips, brushes, and mop pads, which must be replaced or serviced by the user from time to time, are not covered by this warranty.

This warranty does not apply to any defect arising from fair wear and tear, including but not limited to the battery discharging time shortening due to the aging or use. Damage or malfunction caused by the user or any third party whether as a result of accident, negligence, abuse, neglect, or any other use not in accordance with the user guide is not covered by this warranty. An unauthorised repair (or attempted repair)

may void this warranty whether or not damage has been caused by that repair/attempt. Removing or tampering with the Product Rating Label on the product or rendering it illegible will void this warranty.

Except as set out below, BISSELL and its distributors are not liable for any loss or damage that is not foreseeable or for incidental or consequential damages of any nature associated with the use of this product including without limitation loss of profit, loss of business, business interruption, loss of opportunity, distress, inconvenience, or disappointment. Except as set out below, BISSELL's liability will not exceed the purchase price of the product.

BISSELL does not exclude or limit in any way its liability for (a) death or personal injury caused by our negligence or the negligence of our employees, agents or subcontractors; (b) fraud or fraudulent misrepresentation; (c) or for any other matter which cannot be excluded or limited under law.

To make a claim under this warranty contact BISSELL Australia PTY LTD (details below). Contact BISSELL prior to returning any goods. Where agreed, BISSELL will reimburse reasonable postage / handling costs (if any) for returning goods to BISSELL. To claim expenses incurred in making a claim under this warranty please provide BISSELL with a copy of the receipt of the expenses by email or post.

For Australian Consumers Only: Our goods come with guarantees that cannot be excluded under the Australian Consumer Law. You are entitled to a replacement or refund for a major failure and compensation for any other reasonably foreseeable loss or damage. You are also entitled to have the goods repaired or replaced if the goods fail to be of acceptable quality and the failure does not amount to a major failure.

Important Notes

Please keep your original sales receipt. It provides proof of the date of purchase and where it was purchased in the event of a warranty claim. See warranty for details.

Please note that using your BISSELL machine outside of its country of original purchase and/or use with a power converter may damage your BISSELL machine and damage caused by mismatched power voltage will not be covered by your warranty.

Please note that putting vinegar, bleach, dish soap, detergent, homemade soap, and other non-BISSELL products in your BISSELL machine may damage your BISSELL machine. Damage caused by using non-BISSELL products in your machine will not be covered by your warranty.

Consumer Care

If your BISSELL product should require service or to claim under our limited guarantee, please contact us.

Australia

Telephone: 1300 247 735

Website: BISSELL.com.au

Address: 789 Springvale Road, Mulgrave, Victoria 3170

Email: consumercareau@bissell.com

New Zealand

Telephone: 0800 247 735

Website: BISSELL.co.nz

Address: 789 Springvale Road, Mulgrave, Victoria 3170

Email: consumercarenz@bissell.com



©2026 BISSELL Inc. All rights reserved.
Part Number 1813484