

# BISSELL®



## CLEANVIEW™ LIFT-OFF

Model 1190G

What's in the Box? .....	3
Assembly .....	3
Filling the Clean Water Tank.....	4
Cleaning Your Carpet.....	5
Using the Portable Spot & Stain Cleaner .....	6
Emptying the Dirty Water Tank.....	7
Cleaning the Machine.....	8
Cleaning the Portable Machine.....	9
Troubleshooting.....	10
Guarantee.....	12

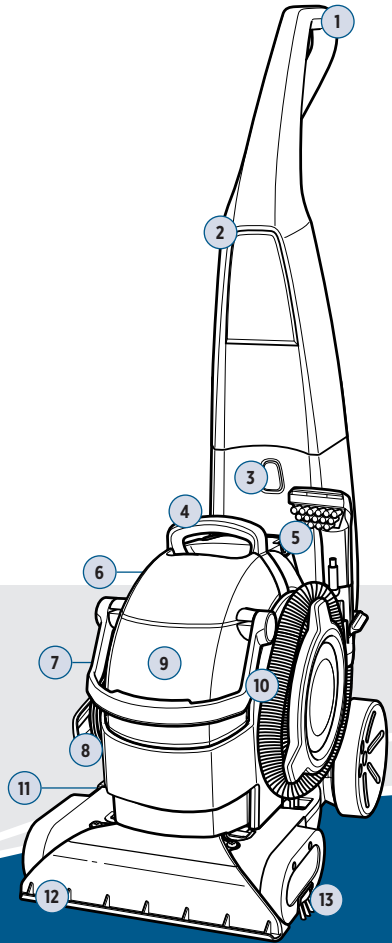

### Product Overview

- |  |   |
|--|---|
| 1. Spray Trigger                         | 9. Dirty Water Tank                             |
| 2. Upper Handle                          | 10. Flex Hose                                   |
| 3. Upright Cleaning Mode Indicator Light | 11. Portable Spot & Stain Cleaner Release Pedal |
| 4. Carry Handle                          | 12. Removeable Nozzle Assembly                  |
| 5. Formula & Water Tank                  | 13. EdgeSweep Brushes                           |
| 6. Power Button                          |   |
| 7. Quick Release Cable Wrap              |   |
| 8. Power Cable                           |   |



**Go online for a comprehensive walkthrough of your new purchase!**

This guide has everything you need to get ready for first use, including setting up, using and maintaining your machine, but online you'll find additional resources like tips and troubleshooting, videos, parts, and more.

Go to **support.BISSELL.com**.

# IMPORTANT SAFETY INSTRUCTIONS

## READ ALL INSTRUCTIONS BEFORE USING YOUR APPLIANCE.

When using an electrical appliance, basic precautions should be observed, including the following:



## WARNING

**TO REDUCE THE RISK OF FIRE, ELECTRIC SHOCK OR INJURY:**

» This appliance is not intended for use by persons (including children) with reduced physical, sensory or mental capabilities, or lack of experience and knowledge, unless they have been given supervision or instruction concerning use of the appliance by a person responsible for their safety.

» Children should be supervised to ensure that they do not play with the appliance.

» Unplug from electrical socket when not in use, before cleaning, maintaining, or servicing the appliance, and if your appliance has an accessory tool with a moving brush, before connecting or disconnecting the tool.

» Do not immerse in water or liquid.

» Keep hair, loose clothing, fingers, and all parts of body away from openings and moving parts of the appliance and its accessories.

» Do not immerse. Use only on surfaces moistened by the cleaning process. Use only BISSELL® cleaning products intended for use with this machine.

» Use only the type and amount of liquids specified under the operations section of this guide.

» Use only on carpet moistened by the cleaning process.

» Liquid must not be directed towards equipment containing electrical

components.

- » Always connect to a properly earthed electrical socket. Do not modify earthed plug.
- » Always install float before any wet pick-up operation.
- » Plastic film can be dangerous. To avoid danger of suffocation, keep away from children.
- » Use only as described in this user guide.
- » Use only manufacturer's recommended attachments.
- » If appliance is not working as it should, has been dropped, damaged, left outdoors, or dropped into water; do not attempt to operate it and have it repaired at an authorised service center.
- » Do not put any object into openings.
- » Do not use with any opening blocked; keep free of dust, lint, hair, and anything that may reduce air flow.
- » Use extra care when cleaning on stairs.
- » Do not use to pick up flammable or combustible liquids, such as petroleum, or use in areas where they may be present.
- » Do not pick up toxic material (chlorine bleach, ammonia, drain cleaner, etc.).
- » Do not use appliance in an enclosed space filled with vapours given off by oil-based paint, paint thinner, some moth-proofing substances, flammable dust, or other explosive or toxic vapours.
- » Do not pick up hard or sharp objects such as glass, nails, screws, coins, etc.
- » Do not pick up anything that is burning or smoking, such as cigarettes, matches or hot ashes.
- » Do not use without filters in place.
- » Use indoors only.
- » If the supply cable is damaged, it must be replaced by the manufacturer, its service agent or similarly qualified person in order to avoid a hazard.
- » Do not run appliance over cable.
- » Do not leave appliance when plugged in.
- » Do not use with damaged cable or plug.
- » Do not pull or carry by cable, use cable as a handle, close door on cable, or pull cable around sharp edges or corners.
- » Keep cable away from heated surfaces.
- » To unplug, grasp the plug, not the cable.
- » Do not handle plug or appliance with wet hands.
- » Turn off all controls before unplugging.

## SAVE THESE INSTRUCTIONS

**ORIGINAL INSTRUCTIONS. FOR OPERATION ON A 220-240 VOLT A.C. 50-60 HZ POWER SUPPLY ONLY. THIS MODEL IS FOR HOUSEHOLD USE ONLY.**

## IMPORTANT INFORMATION







» Keep appliance on a level surface.

» If your appliance has a motorised Brush Roll, do not leave machine running in the same spot without the handle fully upright.

» To reduce the risk of a leaking condition, do not store unit where freezing may occur. Damage to internal components may result.

## What's in the Box?

Standard accessories may vary by model. To identify what should be included with your purchase, please refer to the "Carton Contents" list located on the carton top flap.

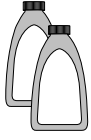
							
Handle	Base	Deep Reach Tool	15cm Upholstery Tool	Spraying Crevice Tool	Nozzle Clean Out Tool	Mesh Bag	2 Trial Size Formulas

## Assembly

▶ Go to [support.BISSELL.com](http://support.BISSELL.com) for assembly videos.

Required for Assembly



Phillips-head Screwdriver

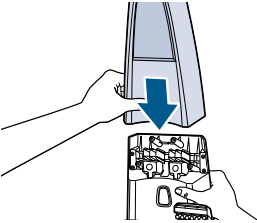

**1.** Slide the Upper Handle onto the body of the machine by guiding the 2 posts on the body into the opening on the Upper Handle.

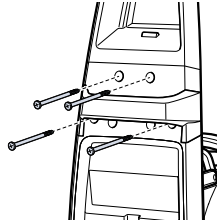

**2.** Firmly holding the Upper Handle in place, screw 2 screws into the marked holes at an upward angle. Screw the remaining screws into the outermost holes under the support handle.

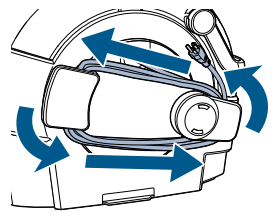

**3.** Wrap Power Cable around Quick Release Cable Wrap.

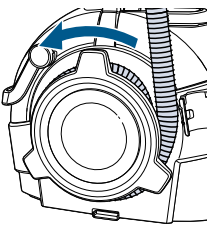

**4.** Wrap Flex Hose around the hose wrap and secure with latch.



**5.** Align the portable spot & stain cleaner and push down firmly until it's secured. Plug the machine in and turn ON to make sure the Upright Cleaning Mode Indicator Light illuminates. If it does not, remove and reset the portable cleaner so it's secure.



**6.** Snap attachment(s) into the back of unit.

**Note:** Portable spot & stain cleaner must be fully secure to operate in upright cleaning mode.

## Filling the Clean Water Tank

For additional tips and tricks on filling your Formula Tank visit [support.BISSELL.com](https://support.BISSELL.com).

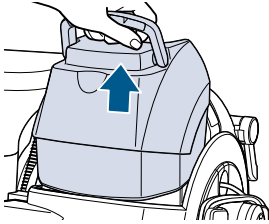

**1.** Remove tank from the base of the machine.

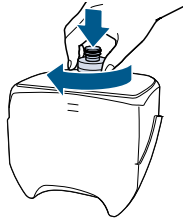

**2.** Unscrew the black cap and remove bottle insert.

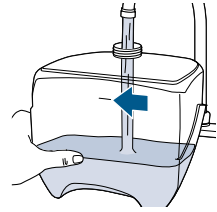

**3.** Fill tank with hand hot (60°C/140°F MAX) tap water to the water fill line. Do not boil or microwave water as it can destroy the tank.

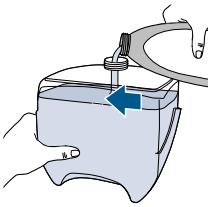

**4.** Add 60 mL of BISSELL® formula to the tank.

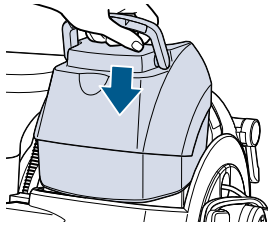

**5.** Replace the cap and return the tank to the machine.

# Cleaning Your Carpet

For additional carpet cleaning tips and tricks, visit [support.BISSELL.com](https://support.BISSELL.com).

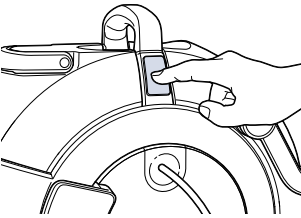

**1.** Plug into a proper outlet and press the Power Button.

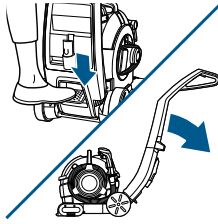

**2.** Press the gray recline pedal, on the back of the machine in between the wheels.

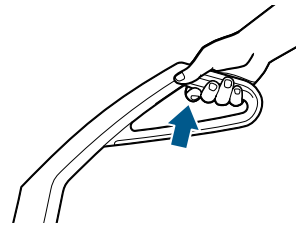

**3.** Press the Spray Trigger and make one slow forward wet pass and another back. Do not overwet.

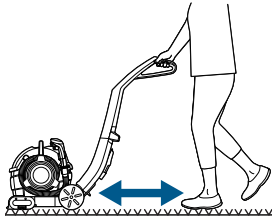

**4.** Release the Spray Trigger and make one slow forward and backward pass over the same area.

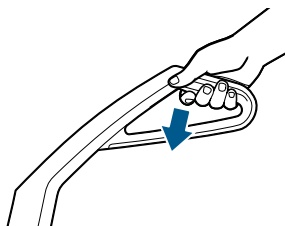

**5.** Repeat passes until solution being suctioned up appears clean. Continue passes without pressing the Spray Trigger until you can't see any more water being suctioned up. This helps speed up dry time.

**CAUTION** Take care not to run over loose objects or edges of area rugs. Stalling the brush may result in premature belt failure.

**ATTENTION** Some Berber carpets have a tendency to fuzz with wear. Repeated strokes in the same area with an ordinary vacuum or carpet cleaner may aggravate this condition.

# Using the Portable Spot & Stain Cleaner

» Your Portable Spot & Stain Cleaner comes equipped with a hose and at least one cleaning tool for cleaning stairs, upholstery and more. Find more tools at [BISSELL.com.au](http://BISSELL.com.au).

## Tips

- » Check for colourfastness in an inconspicuous place before cleaning larger area.
- » If possible, check upholstery stuffing. Coloured stuffing may bleed through fabric when wet.
- » Vacuum thoroughly to pick up loose debris and pet hair.
- » Check manufacturer's tag before cleaning. Do not use on velvet or silk. If manufacturer's tag is missing or not coded, check with your furniture dealer.

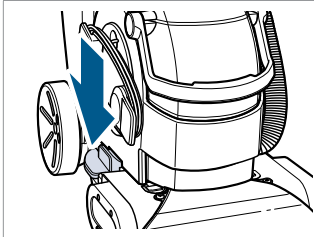

**1.** Step on the Portable Spot & Stain Cleaner Release Pedal to release the portable spot & stain cleaner.

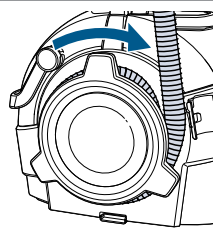

**2.** Release Flex Hose by twisting the hose secure latch clockwise. Unwrap hose completely.

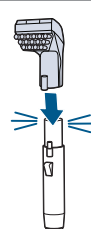

**3.** Attach the desired cleaning tool to the hose grip until it snaps together.

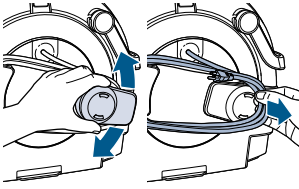

**4.** Twist the Quick Release Cable Wrap clockwise to unwrap the cable completely and plug into grounded outlet.

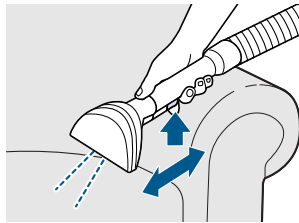

**5.** Hold the tool approximately 2.5 cm above the soiled surface. Press the Spray Trigger to apply the cleaning solution. Do not overwet.

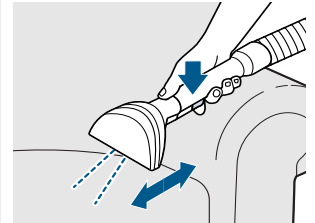

**6.** Release the Spray Trigger while applying downward pressure on the tool and pull it toward you. The suction will remove the dirt and cleaning solution. Continue until no more dirt can be removed.

## Emptying the Dirty Water Tank

👉 We have additional tips for maintaining your machine at [support.BISSELL.com](http://support.BISSELL.com).

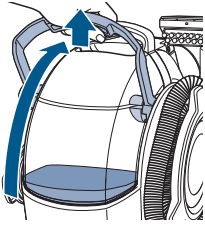

**1.** Remove tank and carry to a utility sink, toilet or outside (where you will dispose of the dirty water).

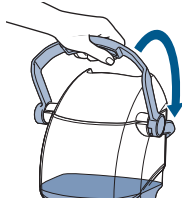

**2.** To unlock the tank's lid, rotate handle over the back of the tank.

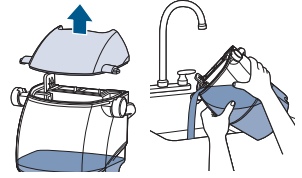

**3.** Remove lid and pour out dirty water. Rinse tank to remove debris.

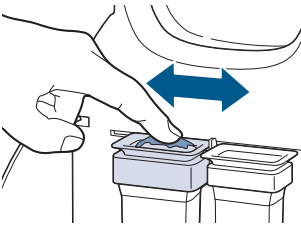

**4.** Wipe debris from the red filter located behind the Dirty Water Tank.

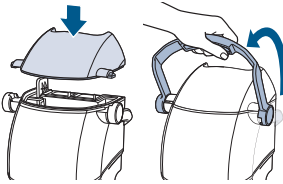

**5.** Replace top of tank and rotate the handle forward to lock in place.

# Cleaning the Machine

Our help doesn't stop here, visit [support.BISSELL.com](http://support.BISSELL.com) for additional help.

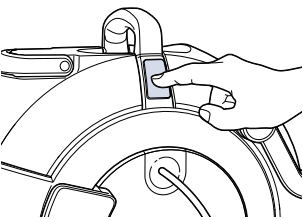

**1.** Turn the machine OFF and wrap up the Power Cable. Make sure the Dirty Water Tank and the Formula & Water Tank are emptied, rinsed and dried before the next use.

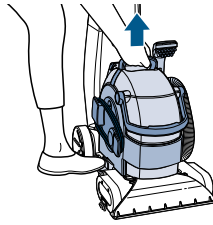

**2.** Remove portable spot & stain cleaner from the base of the machine.

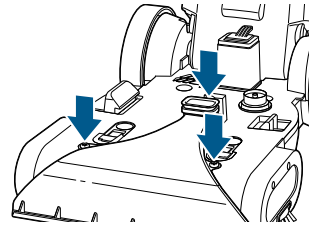

**3.** Remove the nozzle assembly by unscrewing 3 screws and lifting away the upper and lower nozzle.

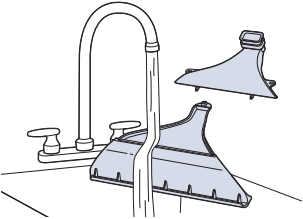

**4.** Rinse upper and lower nozzles under clean water.

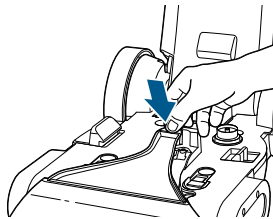

**5.** Place lower nozzle back onto the machine by hooking the tabs into the holes on the bottom sides of the front of the machine.

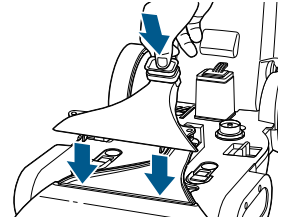

**6.** Place upper nozzle onto the lower nozzle by hooking the tabs into the holes on the front of the lower nozzle. Secure with 3 screws.

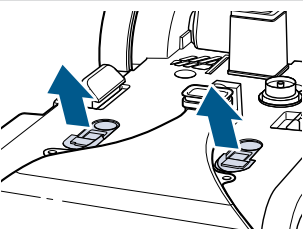

**7.** Clean the spray tips. To remove black spray tip, unlatch tab on front of spray tip from base of machine and pull up and out of green receiver.

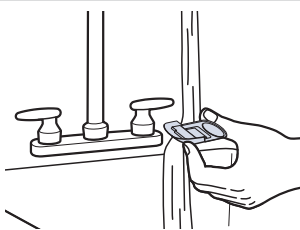

**8.** Rinse under water to clean.



**9.** Replace spray tip by inserting back into red receiver and latching tab into base of machine. Repeat steps for second spray tip.

**⚠ WARNING** To reduce the risk of electric shock, turn power OFF and disconnect plug from electrical outlet before performing maintenance or troubleshooting checks.



# Cleaning the Portable Machine

↖ For additional tips on cleaning your portable machine after use, visit [support.BISSELL.com](http://support.BISSELL.com).



**1.** Before turning OFF the machine, suction up clean water from a bowl to rinse out the hose. Then, lift the tool and point it upwards to drain remaining water into the tank.

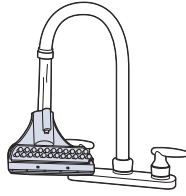

**2.** Remove and rinse the tools in clean, running water. Dry and replace in the tool storage provided.

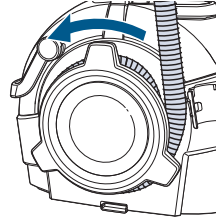

**3.** Wrap up the hose and secure it with the latch.

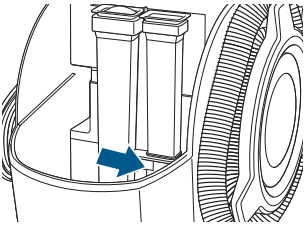

**4.** Check suction gate for debris. The suction gate automatically diverts air when the portable spot & stain cleaner is detached.

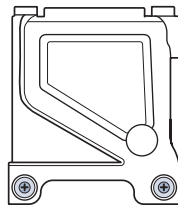

**5.** To clean suction gate, remove two screws and pull off suction gate door.

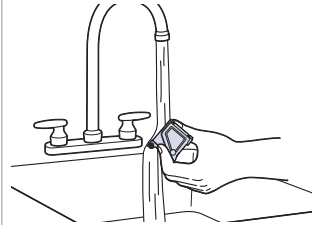

**6.** Wipe suction gate clean and rinse suction gate door. Once dry, replace suction gate door and two screws.

**⚠ WARNING** To reduce the risk of electric shock, turn power OFF and disconnect plug from electrical outlet before performing maintenance or troubleshooting checks.

## Troubleshooting

Below are some of the issues you may run into. If you don't see the issue you're experiencing below, visit [support.BISSELL.com](http://support.BISSELL.com).

Problem	Possible Cause	Remedies
Upright Cleaning Mode Indicator Light does not illuminate	The power is not turned ON.	The power must be ON to activate the indicator light.
	The portable spot & stain cleaner is not attached completely.	Make sure the portable spot & stain cleaner is attached. Push down firmly to check.
Reduced/no spray	Formula & Water Tank may be empty.	Refill tank.
	Formula & Water Tank may not be seated completely.	Turn power OFF. Remove and reseal tank.
	Pump may have lost prime in portable spot cleaning mode.	Hold end of hose below water level in tank to prime.
	The portable spot & stain cleaner is not attached completely.	Push down firmly to check connection.
DirtLifter PowerBrush does not turn	The portable spot & stain cleaner is not attached completely.	Make sure the portable spot & stain cleaner is attached. Push down firmly to check.
	The unit is in the upright position.	Brushes only rotate when unit is reclined using the recline pedal.
	Circuit breaker on machine (if equipped) may have tripped.	Turn the machine OFF and unplug from outlet. Check to see if foreign object is caught in Brush Roll. Remove object. Plug machine in to reset circuit breaker.
	The belt is off or broken.	Turn power OFF and unplug unit from outlet. Visit <a href="http://support.BISSELL.com">support.BISSELL.com</a> for instructions on replacing the belt.
Loss of suction power	Tanks may not be seated properly.	Pick up both tanks and reseal them so they fit snugly on the unit.
	Nozzles may not be assembled properly.	Unplug the unit. Check to make sure the "lip" of the nozzle is securely hooked into the groove on bottom of the machine (see page 8).
	The portable spot & stain cleaner is not attached completely.	Make sure the portable spot & stain cleaner is attached. Push down firmly to check.
	Dirty Water Tank has picked up maximum amount of dirty water and has reached full line.	Empty Dirty Water Tank.
	Formula & Water Tank is empty.	Check fluid levels in tank.
	Suction gate is open.	Check to make sure the suction gate is closed. Follow "Cleaning the Suction Gate" instructions on page 9.

**⚠ WARNING** To reduce the risk of electric shock, turn power OFF and disconnect plug from electrical outlet before performing maintenance or troubleshooting checks.



## Guarantee

This guarantee gives you specific legal rights, in addition to rights you may have under the *Australian Consumer Law*. If you need additional instruction regarding this guarantee or have questions regarding what it may cover, please contact your local BISSELL® Consumer Care on the details set out below.

### BISSELL Two Year Guarantee

Subject to the \*conditions identified below, BISSELL will repair or replace (with new, refurbished, lightly used, or remanufactured components or products), at BISSELL's option, free of charge from the date of purchase by the original purchaser, for two years any defective or malfunctioning part due to manufacturer defect. This guarantee applies to product used for personal purposes, and not commercial or rental service. This guarantee does not apply to fans or routine maintenance or consumable components such as filters, belts, brush rolls, etc., damage or malfunction caused by negligence, abuse, neglect, unauthorized repair, or any other use not in accordance with the user guide. BISSELL recommends that the original packaging be kept for the duration of the guarantee period in case such need arises within the guarantee period that the item needs re-packing and transportation.

### \*Conditions of Guarantee

Subject to whether such loss is reasonably foreseeable, BISSELL and its in-country distributors are not liable for incidental or consequential damages of any nature associated with the use of this product.

**For Australian Consumers Only:** Our goods come with guarantees that cannot be excluded under the Australian Consumer Law. You are entitled to a replacement or refund for a major failure and for compensation for any other reasonably foreseeable loss or damage. You are also entitled to have the goods repaired or replaced if the goods fail to be of acceptable quality and the failure does not amount to a major failure.

This guarantee is in addition to other rights or remedies under law. Nothing in this guarantee excludes, limits or modifies any liability of BISSELL which is imposed by law, or limits or modifies any remedy available to the consumer which is granted by law. To make a claim under this guarantee contact BISSELL Australia PTY LTD (details above). Contact BISSELL prior to returning any goods. Where agreed, BISSELL will reimburse reasonable postage / handling costs (if any) for returning goods to BISSELL. To claim expenses incurred in making a claim under this guarantee please provide BISSELL with a copy of the receipt of the expenses by email or post.

### Consumer Care

#### Australia

Telephone: 1300 247 735

Website: [www.BISSELL.com.au](http://www.BISSELL.com.au)

#### New Zealand

Telephone: 0800 247 735

Website: [www.BISSELL.co.nz](http://www.BISSELL.co.nz)

## But wait, there's more!

Join us online for a complete guide to your new product, including troubleshooting, parts and more.

**Go to [BISSELL.com](http://BISSELL.com).**



INFO



VIDEOS



PARTS

