

Bissell®

POWERCLEAN Carpet Cleaner

USER GUIDE
2771B

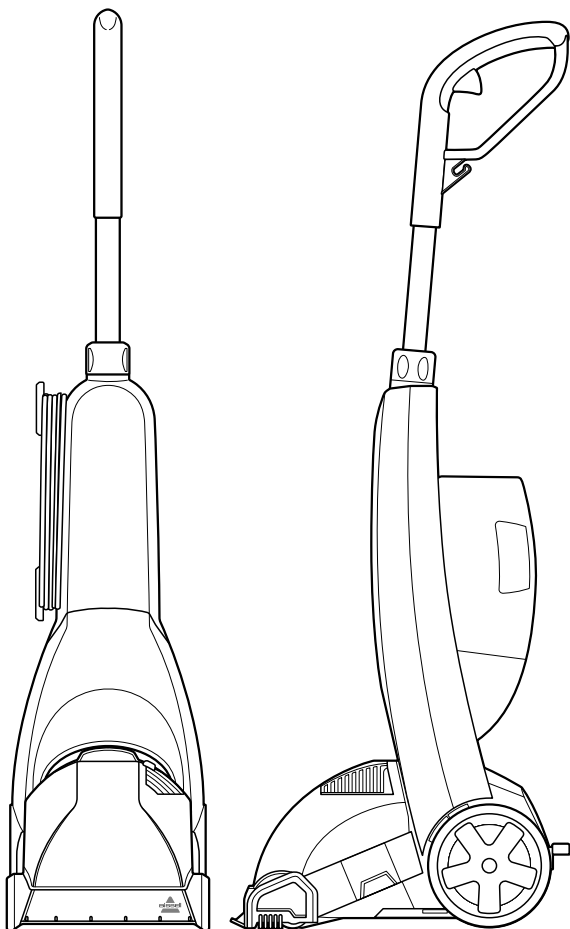

IMPORTANT SAFETY INSTRUCTIONS

READ ALL INSTRUCTIONS BEFORE USING YOUR APPLIANCE.

When using an electrical appliance, basic precautions should be observed, including the following:



WARNING

TO REDUCE THE RISK OF FIRE, ELECTRIC SHOCK OR INJURY:

- » This appliance can be used by children aged from 8 years and above and persons with reduced physical, sensory or mental capabilities or lack of experience and knowledge if they have been given supervision or instruction concerning use of the appliance in a safe way and understand the hazards involved. Cleaning and user maintenance shall not be made by children without supervision.
 - » Children should be supervised to ensure that they do not play with the appliance.
 - » Keep hair, loose clothing, fingers, and all parts of body away from openings and moving parts of the appliance and its accessories.
 - » Unplug from electrical socket when not in use, before cleaning, maintaining or servicing the appliance, and if your appliance has an accessory tool with a moving brush, before connecting or disconnecting the tool.
 - » If the supply cable is damaged, it must be replaced by the manufacturer, its service agent, or similarly qualified person in order to avoid a hazard.
 - » Do not run appliance over cable, a hazard may occur.
 - » Do not leave appliance when plugged in.
 - » Do not use with damaged cable or plug.
 - » Do not pull or carry by cable, use cable as a Handle, close door on cable, or pull cable around sharp edges or corners.
 - » Keep cable away from heated surfaces.
 - » To unplug, grasp the plug, not the cable.
 - » Do not handle plug or appliance with wet hands.
 - » Turn OFF all controls before unplugging.
 - » Plastic film can be dangerous. To avoid danger of suffocation, keep away from children.
- » Use only as described in this user guide.
 - » Use only manufacturer's recommended attachments.
 - » Do not immerse in water or liquid.
 - » If appliance is not working as it should, has been dropped, damaged, left outdoors, or dropped into water; do not attempt to operate it and have it repaired at an authorized service center.
 - » Do not put any object into openings.
 - » Do not use with any opening blocked; keep free of dust, lint, hair, and anything that may reduce air flow.
 - » Use extra care when cleaning on stairs.
 - » Do not use to pick up flammable or combustible liquids, such as petroleum, or use in areas where they may be present.
 - » Do not pick up toxic material (chlorine bleach, ammonia, drain cleaner, etc).
 - » Do not use appliance in an enclosed space filled with vapours given off by oil-based paint, paint thinner, some moth-proofing substances, flammable dust, or other explosive or toxic vapours.
 - » Do not pick up hard or sharp objects such as glass, nails, screws, coins, etc.
 - » Do not pick up anything that is burning or smoking, such as cigarettes, matches or hot ashes.
 - » Have servicing performed by a qualified repair person using only identical replacement parts. This will ensure that the safety of the product is maintained.
 - » Operators shall be adequately instructed on the use of these machines.
 - » Always connect to a properly earthed electrical socket. Do not modify earthed plug.
 - » Liquid must not be directed towards equipment containing electrical components.
 - » Do not immerse. Use only on surfaces moistened by the cleaning process. Use only BISSELL® cleaning products intended for use with this machine.
 - » Use only the type and amount of liquids specified under the operations section of this guide.
 - » Use indoors only.
 - » Have servicing performed by a qualified repair person using only identical replacement parts. This will ensure that the safety of the product is maintained.
 - » Operators shall be adequately instructed on the use of these machines.
 - » Do not use without filters in place.
 - » Use only on carpet moistened by cleaning process.

SAVE THESE INSTRUCTIONS

ORIGINAL INSTRUCTIONS.

FOR OPERATION ON A 220-240 VOLT A.C. 50-60 HZ POWER SUPPLY ONLY.

THIS MODEL IS FOR HOUSEHOLD USE ONLY.

IMPORTANT INFORMATION

- » Keep appliance on a level surface.
- » If your appliance has a motorised Brush Roll, do not leave machine running in the same spot without the Handle fully upright.
- » To reduce the risk of a leaking condition, do not store unit where freezing may occur. Damage to internal components may result.

Thanks for buying a BISSELL® carpet cleaner!

We love to clean and we're excited to share one of our innovative products with you. We want your carpet cleaner to work like new for the years to come, so this guide has tips on how to use, maintain and, if there's a problem, troubleshoot.

Your carpet cleaner needs a little assembly before getting to work, so flip to the "Assembly" section and let's get started!

What's In The Box?



Upper Body



Handle Post

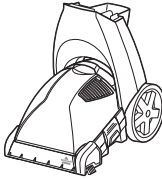

Lower Body



Clean Tank



Trial Size Formula

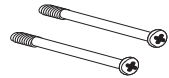

Two Screws

NOTE: Standard accessories may vary by model. To identify what should be included with your purchase, please refer to the "Carton Contents" list located on the carton top flap.

Safety Instructions.....	2
Product View.....	4
Assembly.....	5
Cleaning Formulas.....	6
Operations.....	7-8

Maintenance & Care.....	9-12
Troubleshooting.....	13
Guarantee.....	14
Consumer Care.....	14

Product View

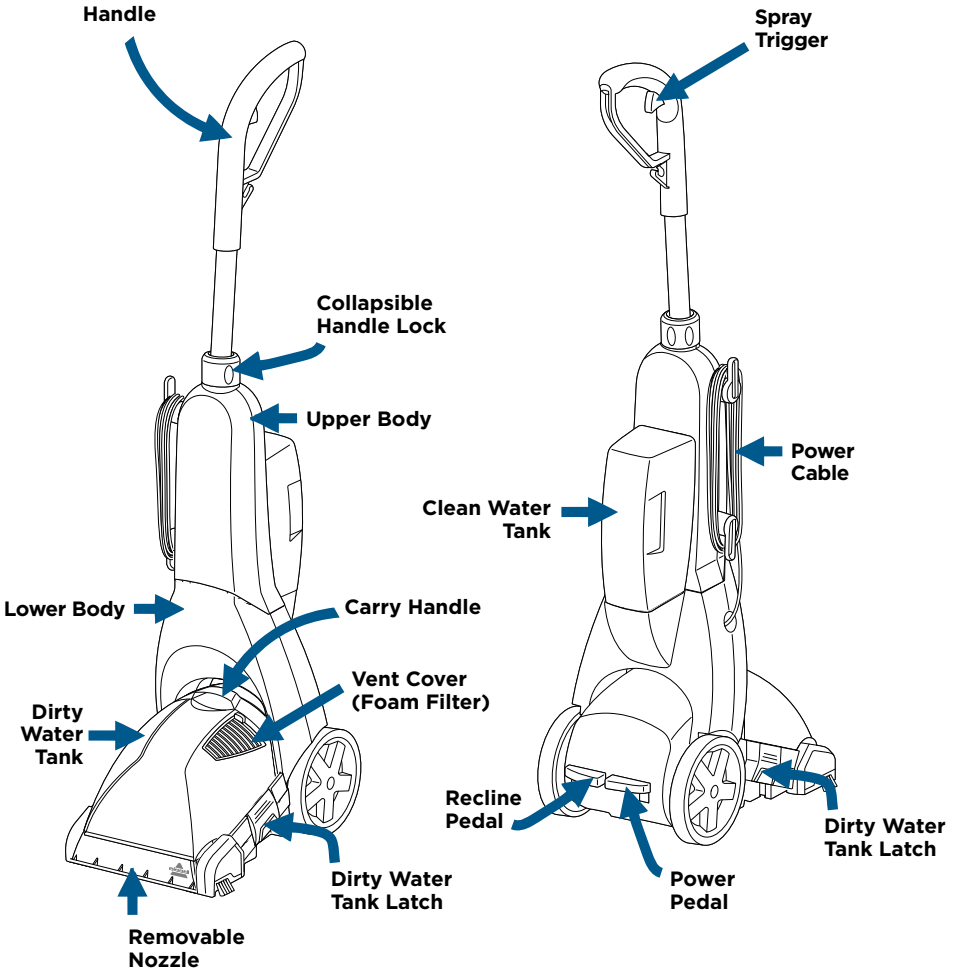

Assembly

⚠ WARNING

Do not plug in your carpet cleaner until you are familiar with all instructions and operating procedures.

The only tool you will need to assemble your cleaner is a Phillips-head screwdriver.



1

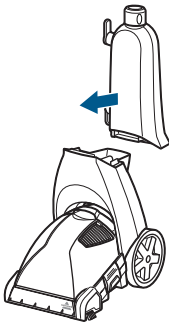

Slide Upper Body onto Lower Body.

2

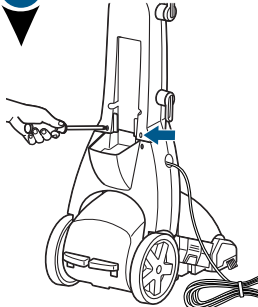

Secure with screws.

3

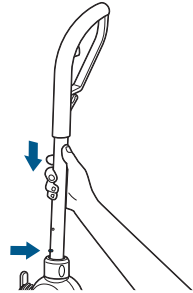

Slide Handle post into the body by aligning the pin and sliding the post down into place.

4

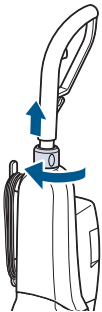

Be sure to secure Upper Handle before lifting. Rotate lock collar to secure.

5

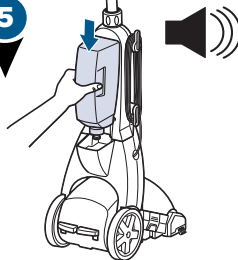

Place Clean Water Tank on back of unit. The tank will make a "click" noise when seated properly.

6

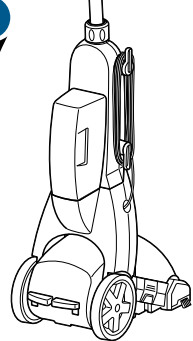

Wrap Power Cable.

Tips Before Carpet Cleaning

- If cleaning an entire room, consider moving your furniture to another area.
- Remove loose dirt and impediments before cleaning.
- Pre-treat stains with BISSELL® Pretreat to improve performance on stains and ground-in dirt.

Cleaning Formulas

WARNING







To reduce the risk of fire and electric shock due to internal component damage, use only BISSELL® cleaning formulas intended for use with the carpet cleaner.

Keep plenty of genuine BISSELL formula on hand so you can clean and protect whenever it fits your schedule.

Always use genuine BISSELL carpet cleaning formulas. Non-BISSELL cleaning formulas may harm the machine and may void the guarantee.

NOTICE: Use of cleaning formulas which contain lemon, eucalyptus or pine oil may damage this appliance and void the guarantee. Chemical spot cleaners or solvent-based soil removers also should not be used. These products may react with the plastic materials used in your cleaner, causing cracking or pitting.

PRETREAT PRETREAT SPOTS AND STAINS TO IMPROVE CARPET CLEANING		BOOST CARPET CLEANING FORMULA ENHANCER
		
Stain Pretreat	Pet Stain Pretreat	Oxy Boost
Pretreat to penetrate and loosen tough stains	Pretreat to help remove tough pet stains and odours	Removes old, set-in stains permanently

2X* CONCENTRATED CLEANING FORMULAS						
WASH & PROTECT			WASH & REMOVE	WASH & REFRESH		WASH & SHINE
						
Professional Stain & Odour	Pet Stain & Odour	Stain & Odour	Allergen Removal	Ambipur Blossom & Breeze	Natural Orange	Hard Floor
Professional strength to remove extra tough stains and odours <i>Includes Scotchgard™ Protector</i>	Removes tough pet stains and contains odour removal technology <i>Includes Scotchgard™ Protector</i>	Removes tough stains and odours <i>Includes Scotchgard™ Protector</i>	Helps remove allergens like pet, pollen and dust mite waste	Powerful cleaning with a refreshing spring scent	Powerful cleaning with a refreshing natural orange scent	Removes tough dirt and grime and leaves a natural shine

ONLY BISSELL Wash & Protect formulas protect from future stains with Scotchgard™ Protector. Scotchgard™ is a trademark of 3M®.

*60 mL of 2X concentrated formula is equivalent to 120 mL of non-concentrated formula.

Certain trademarks used under license from The Procter & Gamble Company or its affiliates.

Filling the Clean Water Tank

1

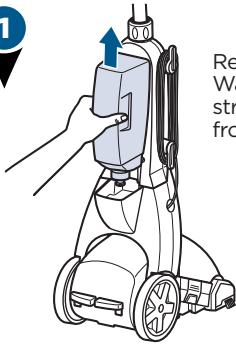

Remove the Clean Water Tank by lifting straight up and away from Lower Body.

2

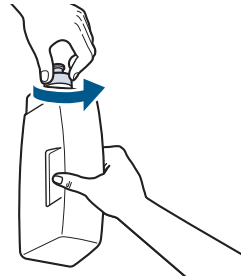

Unscrew the cap at the bottom of the Clean Water Tank.

3

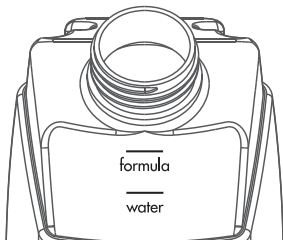

Fill with warm tap water to the WATER line. Fill the rest of the tank with BISSELL formula to the FORMULA line.

4

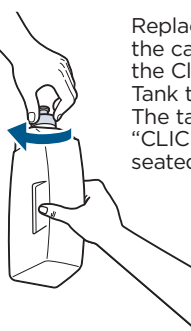

Replace and tighten the cap, then return the Clean Water Tank to Lower Body. The tank will make a "CLICK" noise when seated properly.

A few notes about filling the Clean Water Tank:

- Fill with warm (140°F/60°C MAX) tap water and add the appropriate BISSELL formula. **DO NOT USE BOILING WATER. DO NOT HEAT WATER OR TANK IN MICROWAVE.**

NOTICE: Do not overwet carpet. Be careful not to run over loose objects or edges of area rugs. Stalling the brush may result in premature Belt failure.

NOTE: Do not substitute BISSELL formula with other household cleaning products.



Pour in more power with BISSELL® OXY Boost

- Fill tank with water and BISSELL formula.
- Add 29.5 ml of BISSELL OXY Boost per 1.89 Liter of water.
- PowerClean has a 1.89 Liter tank.

Cleaning Your Carpet

Important! Please check manufacturer's tag before cleaning area rugs for any specialized cleaning instructions. We do not recommend deep cleaning delicate, silk, wool, antique or area rugs without a manufacturer's tag.

1

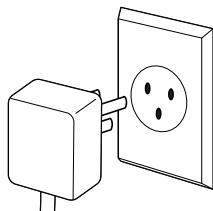

Plug into a proper outlet.

2

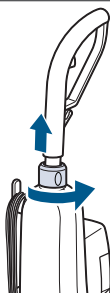

Extend the Handle Post by turning the collar counter-clockwise and lifting the Handle up. Turn the collar clockwise to secure.

IMPORTANT BEFORE USE: Make sure the Handle Post is fully extended up and the collar lines up with the lock symbol before you begin cleaning.

3

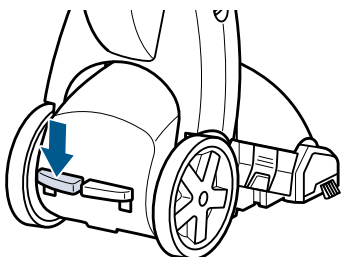

Press the grey Recline Pedal next to the Power Pedal with your foot.

4

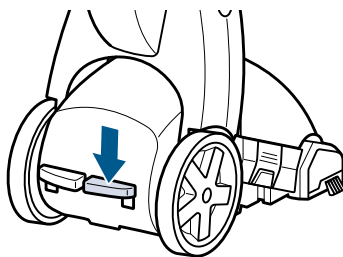

Press the red Power Pedal with your foot.

5



Cleaning Pass:

1. While pressing the trigger, make one slow forward wet pass and another one back.
2. Release the trigger and make one slow forward and backward pass over the same area.
3. Repeat steps 1 and 2 until formula being pulled up appears clean.
4. Empty the Dirty Water Tank when dirty water reaches the full line, and fill with fresh warm water and formula when the Clean Water Tank is empty.

Emptying the Dirty Water Tank

⚠️ WARNING

To reduce the risk of fire, electric shock or injury, turn power OFF and disconnect plug from electrical outlet before performing maintenance or troubleshooting.

1

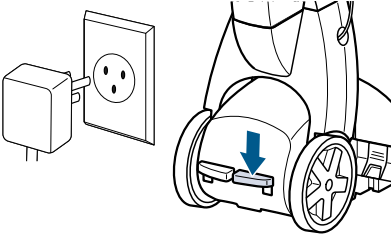

Press the Power Pedal with your foot to turn OFF the unit. Then unplug it.

2

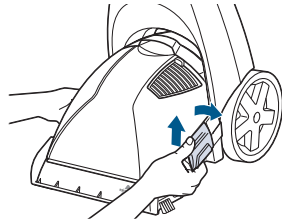

Release Dirty Water Tank latches (on each side) by pulling up from the bottom of latch and then out.

3

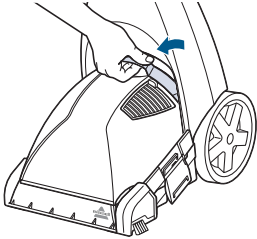

Carefully remove tank by lifting up on the tank Carry Handle.

4

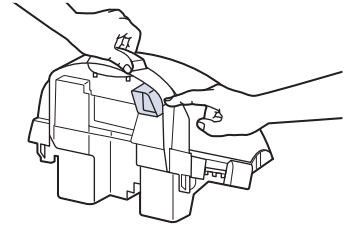

Carry the Dirty Water Tank to a sink. To empty, tilt tank and pour out contents using the opening at the back of tank.

5

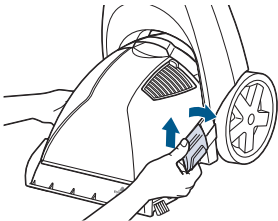

Rinse the Dirty Water Tank thoroughly and replace on unit. Secure latches on both sides of the tank.

6

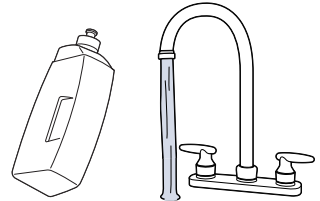

Refill the Clean Water Tank and continue cleaning or if you're done cleaning, wait for the pieces to dry before storing your machine.

Cleaning Machine After Use

⚠️ WARNING

To reduce the risk of electric shock, turn power OFF and disconnect plug from electrical outlet before performing maintenance or troubleshooting checks.

1

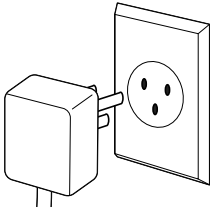

Unplug the unit.

2

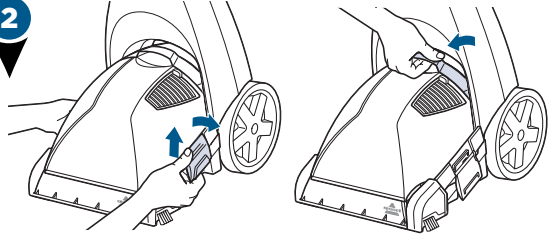

Remove and rinse the Dirty Water Tank thoroughly.

3

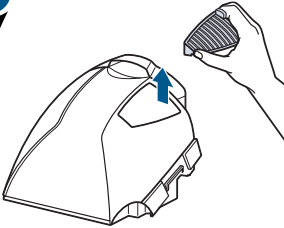

Remove tank vent & foam filter (located on top of the Dirty Water Tank) and rinse.

4



To remove and clean the nozzle, keep the Dirty Water Tank off of the unit.

Gently pull the two tabs that point up near the front of the unit. The nozzle will unhook to remove. Rinse with water. When finished, slightly tilt the machine so the foot raises up so you can align the nozzle hooks at the floor of the unit. Rotate the nozzle up to clip back into place.

5

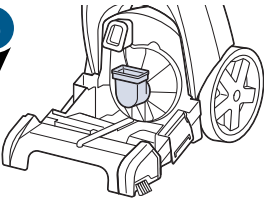

Remove lint and hair from red gasket in base of unit. (Do not remove gasket.)

6

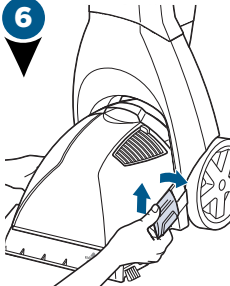

Once the parts have been rinsed clean and dried, replace the Dirty Water Tank to the base of the machine and secure with both latches. Wrap Power Cable around Quick Release Cable Wrap on side of the machine. Wipe all surfaces with a soft cloth and store cleaner upright in a protected, dry area.

NOTICE: To reduce the risk of a leaking condition, do not store unit where freezing may occur. Damage to internal components may result.

Replacing Belts & Brush Rolls

WARNING

To reduce the risk of electric shock, turn power OFF and disconnect plug from electrical outlet before performing maintenance or troubleshooting checks.

What you will need: 1 Phillips-head screwdriver & 1 flathead screwdriver

1

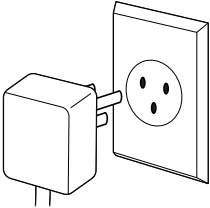

Turn the machine OFF and unplug from wall outlet.

2

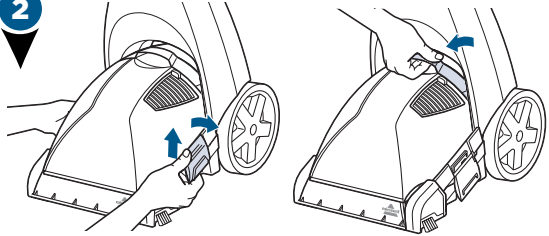

Remove the Clean Water and Dirty Water Tanks.

3

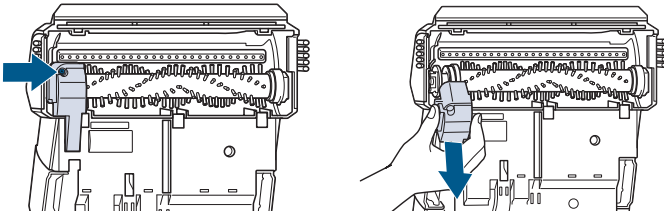

Lay machine down to access the bottom of the machine. With a Phillips-head screwdriver, unscrew the Belt Cover and remove.

4

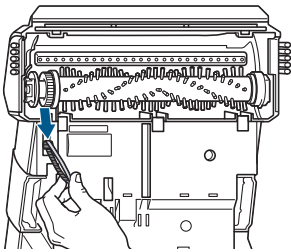

If you want to replace or clean the Brush Roll, remove the Belt by slightly lifting the Brush Roll to maneuver the Belt and remove it. If the Belt is broken and needs to be replaced, remove it and replace with a new Belt.

5

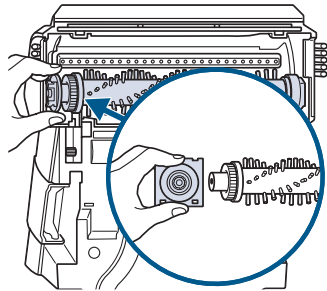

When removing the Brush Roll, the Brush Roll Cap will come with it. Do not lose this part.

Replacing Belts & Brush Rolls (continued)

6

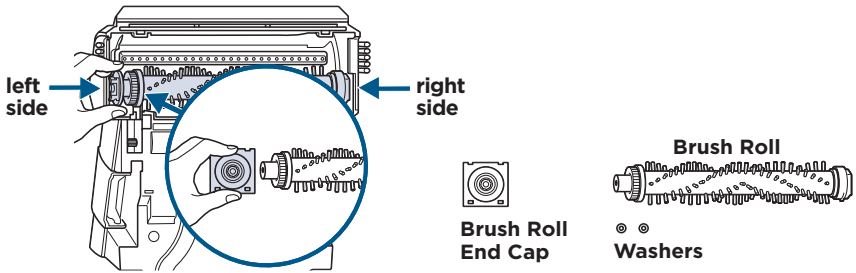

Clean or replace the Brush Roll and Belt. When finished cleaning these parts, reassemble them to the machine.

Insert the brush into the right side end cap. Adjust the right side of the brush into place and tuck the left Brush Roll Cap (separate piece that attaches to Brush Roll) into place.

7

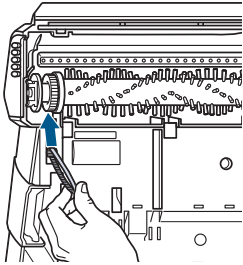

Maneuver the Belt to wrap around the pulley. Wrap the Belt around the cog of the Brush Roll. Secure the Brush Roll into place by sliding the square piece to align the Brush Roll.

8

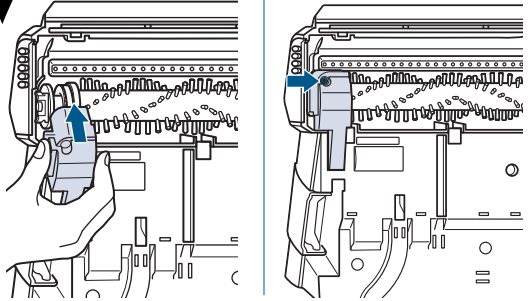

Reattach Belt Cover and screw into place.

NOTE: Manually rotate brush to make sure it rotates freely and the Belt is aligned.

Troubleshooting



WARNING

To reduce the risk of electric shock, turn power OFF and disconnect plug from electrical outlet before performing maintenance or troubleshooting checks.

Problem	Possible causes	Remedies
Reduced spray OR no spray	Clean Water Tank is empty.	Refill tank with water and formula.
	Lint screen on Clean Water Tank cap clogged.	Soak Clean Water Tank cap in warm water and then rinse under running water.
	Spray nozzle clogged.	Clean spray nozzle by rinsing under water.
	Upper Handle is not in the upright and locked position.	Rotate the Collapsible Handle Lock, pull Handle up and return the Handle lock to the locked position.
	Clean Water Tank not properly seated on unit.	Remove tank, ensure cap is tightened properly, and reinstall tank until you hear a "click" noise.
	Upper Handle assembly not fully installed.	Unscrew and reassemble Upper Handle to Lower Body. Ensure trigger on Handle has tension.
Carpet cleaner not picking up cleaning formula	Dirty Water Tank is not aligned/secured.	Check tank alignment and secure with side latches.
	Dirty Water Tank is full.	Empty tank.
	Removable Nozzle installed improperly.	Unplug unit and align two "hooks" into bottom first, then snap into place on top.
	Removable Nozzle full of debris.	Unplug unit, remove nozzle and rinse under running water.
	Red lint screen under Dirty Water Tank is clogged.	Remove debris from lint screen.

Consumer Guarantee

This guarantee gives you specific legal rights, in addition to rights you may have under the Australian Consumer Law. If you need additional instruction regarding this guarantee or have questions regarding what it may cover, please contact your local BISSELL Consumer Services on the details set out below.

Limited 1 Year Guarantee (from the date of purchase by original purchaser)

Subject to the *CONDITIONS identified below, BISSELL will repair or replace (with new, refurbished, lightly used, or remanufactured components or products), at BISSELL's option, free of charge, any defective or malfunctioning part due to manufacturer defect. This guarantee applies to product used for personal purposes, and not commercial or rental service. This guarantee does not apply to fans or routine maintenance or consumable components such as filters, belts, brush rolls, etc., damage or malfunction caused by negligence, abuse, neglect, unauthorized repair, or any other use not in accordance with the user guide. BISSELL recommends that the original packaging be kept for the duration of the guarantee period in case such need arises within the guarantee period that the item needs re-packing and transportation.

It may be necessary to obtain some of your personal information, such as a mailing address, to fulfill terms of this guarantee. Any personal data will be handled pursuant to BISSELL's Privacy Policy, which can be found at www.BISSELL.eu.

*CONDITIONS OF THE GUARANTEE

Subject to whether such loss is reasonably foreseeable, BISSELL and its in-country distributors are not liable for incidental or consequential damages of any nature associated with the use of this product.

FOR AUSTRALIAN CONSUMERS ONLY:

OUR GOODS COME WITH GUARANTEES THAT CANNOT BE EXCLUDED UNDER THE AUSTRALIAN CONSUMER LAW. YOU ARE ENTITLED TO A REPLACEMENT OR REFUND FOR A MAJOR FAILURE AND FOR COMPENSATION FOR ANY OTHER REASONABLY FORESEEABLE LOSS OR DAMAGE. YOU ARE ALSO ENTITLED TO HAVE THE GOODS REPAIRED OR REPLACED IF THE GOODS FAIL TO BE OF ACCEPTABLE QUALITY AND THE FAILURE DOES NOT AMOUNT TO A MAJOR FAILURE.

THIS GUARANTEE IS IN ADDITION TO OTHER RIGHTS OR REMEDIES UNDER LAW. NOTHING IN THIS GUARANTEE EXCLUDES, LIMITS OR MODIFIES ANY LIABILITY OF BISSELL WHICH IS IMPOSED BY LAW, OR LIMITS OR MODIFIES ANY REMEDY AVAILABLE TO THE CONSUMER WHICH IS GRANTED BY LAW. TO MAKE A CLAIM UNDER THIS GUARANTEE CONTACT BISSELL AUSTRALIA PTY LTD (DETAILS BELOW). CONTACT BISSELL PRIOR TO RETURNING ANY GOODS. WHERE AGREED, BISSELL WILL REIMBURSE REASONABLE POSTAGE / HANDLING COSTS (IF ANY) FOR RETURNING GOODS TO BISSELL. TO CLAIM EXPENSES INCURRED IN MAKING A CLAIM UNDER THIS GUARANTEE PLEASE PROVIDE BISSELL WITH A COPY OF THE RECEIPT OF THE EXPENSES BY EMAIL OR POST.

Consumer Care

If your BISSELL® product should require service or to claim under our limited guarantee, please contact us as follows:

Website and Email:

www.BISSELL.com.au
www.BISSELL.co.nz

Telephone:

Australia: 1300-247-735

New Zealand: 0800-247-735

Replacement parts and accessories are available for purchase.
To purchase visit www.BISSELL.com.au

Write:

BISSELL AUSTRALIA PTY LIMITED
42 Rocco Dr.
Scoresby 3179
Victoria
Australia

Visit the BISSELL website: www.BISSELL.com.au

When contacting BISSELL, have model number of cleaner available.

Please record your Model Number: _____

Please record your Purchase Date: _____

NOTE: Please keep your original sales receipt. It provides proof of the date of purchase in the event of a guarantee claim. See guarantee for details.

Notes



©2019 BISSELL Inc.
Grand Rapids, Michigan
All rights reserved. Printed in China
Part Number 161-9030 01/19