



PET HAIR ERASER[®] TURBO

LIGHTWEIGHT & POWERFUL
PET HAIR PICK UP

QUICK START/USER GUIDE
2454 Series



More of a video person? Look for this icon and go online for an instructional how-to video at

www.BISSELL.com.au

IMPORTANT SAFETY INSTRUCTIONS

READ ALL INSTRUCTIONS BEFORE USING YOUR UPRIGHT VACUUM.

Unplug from outlet when not in use and before conducting maintenance. When using an electrical appliance, basic precautions should be observed, including the following:

WARNING

TO REDUCE THE RISK OF FIRE, ELECTRIC SHOCK, OR INJURY:

» This appliance can be used by children aged from 8 years and above and persons with reduced physical, sensory or mental capabilities or lack of experience and knowledge if they have been given supervision or instruction concerning use of the appliance in a safe way and understand the hazards involved. Children shall not play with the appliance. Cleaning and user maintenance shall not be made by children without supervision.

» Children should be supervised to ensure that they do not play with the appliance.

» If the supply cable is damaged it must be replaced by the manufacturer, its service agent, or similarly qualified person in order to avoid a hazard.

» Keep hair, loose clothing, fingers, and all parts of body away from openings and moving parts of the appliance and its accessories.

- » Do not leave appliance when plugged in.
- » Unplug from electrical socket when not in use and before servicing.
- » Do not allow to be used as a toy.
- » Use only as described in this user guide.
- » Use only manufacturer's recommended attachments.
- » Do not use with damaged cable or plug.
- » Do not immerse in water or liquid.
- » If appliance is not working as it should, has been dropped, damaged, left outdoors, or dropped into water; do not attempt to operate it and return it to a service center.
- » Do not pull or carry by cable, use cable as a handle, close door on cable, or pull cable around sharp edges or corners.
- » Do not run appliance over cable.
- » Keep cable away from heated surfaces.
- » Do not unplug by pulling on cable.
- » To unplug, grasp the plug, not the cable.
- » Do not handle plug or appliance with wet hands.
- » Do not put any object into openings.

- » Do not use with any opening blocked; keep free of dust, lint, hair, and anything that may reduce air flow.
- » Turn off all controls before unplugging.
- » Use extra care when cleaning on stairs.
- » Do not use to pick up flammable or combustible liquids, such as petroleum, or use in areas where they may be present.
- » Do not pick up toxic material (chlorine bleach, ammonia, drain cleaner, etc.)
- » Do not use appliance in an enclosed space filled with vapours given off by oil base paint, paint thinner, some mothproofing substances, flammable dust, or other explosive or toxic vapours.
- » Do not pick up hard or sharp objects such as glass, nails, screws, coins, etc.
- » Use only on dry, indoor surfaces.
- » Keep appliance on a level surface.
- » Do not pick up anything that is burning or smoking, such as cigarettes, matches, or hot ashes.
- » Do not use without dust bag and/or filters in place.
- » Do not use outdoors or on wet surfaces
- » This appliance is provided with double insulation. Use only identical replacement parts.
- » Do not leave machine running in the same spot without handle fully upright.
- » Unplug before connecting or disconnecting the TurboBrush® Tool or Pet TurboEraser® Tool.

CAUTION

In order to avoid a hazard due to inadvertent resetting of the thermal cut-out, this appliance must not be supplied through an external switching device, such as a timer, or connected to a circuit that is regularly switched on and off by the utility.

LED LIGHTED CREVICE TOOL WARNING

- » **Caution: Risk of fire and burns. Do not recharge, disassemble, heat above 60°C (140°F) or incinerate. Keep batteries out of reach of children and in original package until ready to use. Dispose of used batteries promptly.**
- » **Never put batteries in mouth. If swallowed, contact your physician or local poison control.**
- » **Replace Battery With CR1632 Only. Use of another battery may present a risk of fire or explosion. CR1632 cells may be purchased anywhere batteries are sold.**

READ OPERATOR'S MANUAL



SAVE THESE INSTRUCTIONS

FOR OPERATION ON A 220-240 VOLT A.C. 50-60 HZ POWER SUPPLY ONLY.

This model is for household use only.

WARNING

- » Plastic film can be dangerous. To avoid danger of suffocation, keep away from children.
- » Do not plug in your vacuum cleaner UNTIL you are familiar with all instructions and operating procedures.
- » To reduce the risk of electrical shock, turn power switch off and disconnect plug from electrical outlet BEFORE performing maintenance or troubleshooting checks.

Quick Start Guide

READ COMPLETE USER GUIDE FOR FULL INSTRUCTIONS ON USE, MAINTENANCE, AND IMPORTANT SAFETY NOTICES.

Assembly

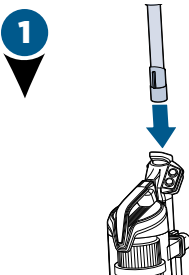

1
Slide end of wand into top of base. It will “click” when inserted correctly.

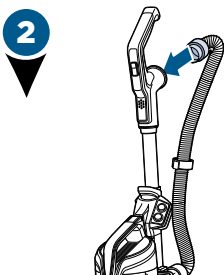

2
Attach Stretch Hose by lining the tabs on the cuff with the notches on the back of the vacuum. Twist clockwise to lock hose into place.

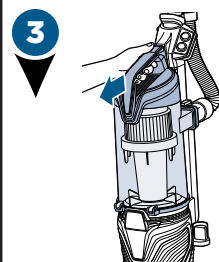

3
Remove Dirt Tank. Press the Dirt Tank Release Button and pull away from vacuum.

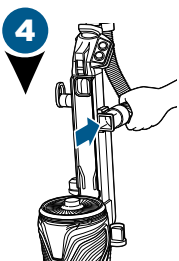

4
Attach end of hose to vacuum by sliding square cuff into the bracket below the power switch.

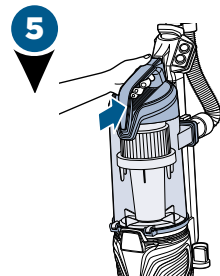

5
Place the Dirt Tank on the vacuum by securing the bottom in place first, then pushing back until you hear a “click”.

Thanks for buying a BISSELL vacuum!

We love to clean and we're excited to share one of our new innovative products with you. We want to make sure your vacuum works as well in five years as it does today, so this guide has tips on using (pages 6-9), maintaining (pages 10-13), and if there is a problem, troubleshooting (page 14).

What's in the Box?

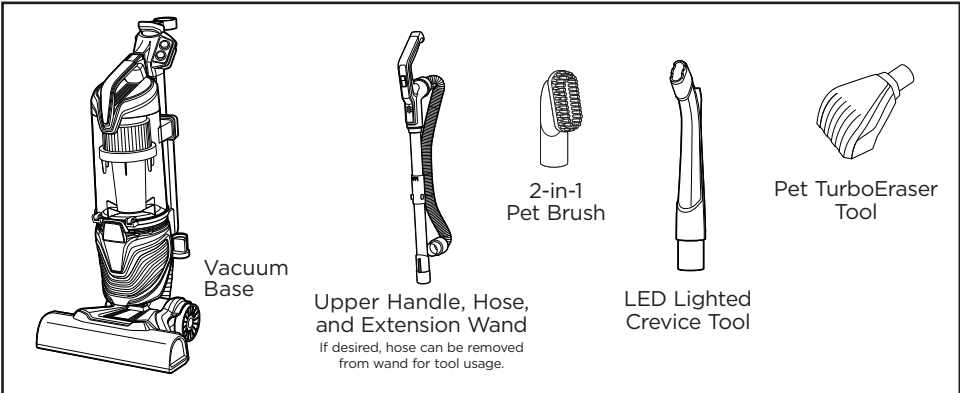

NOTE: Standard accessories may vary by model. To identify what should be included with your purchase, please refer to the “Carton Contents” list located on the carton top flap.

Quick Start / Assembly	2	Troubleshooting	14
Safety Instructions	3	Guarantee	15
Product View	5	Service	15
Operations	6-9	Product Registration	16
Maintenance & Care	10-13	Parts & Supplies	16

Product View

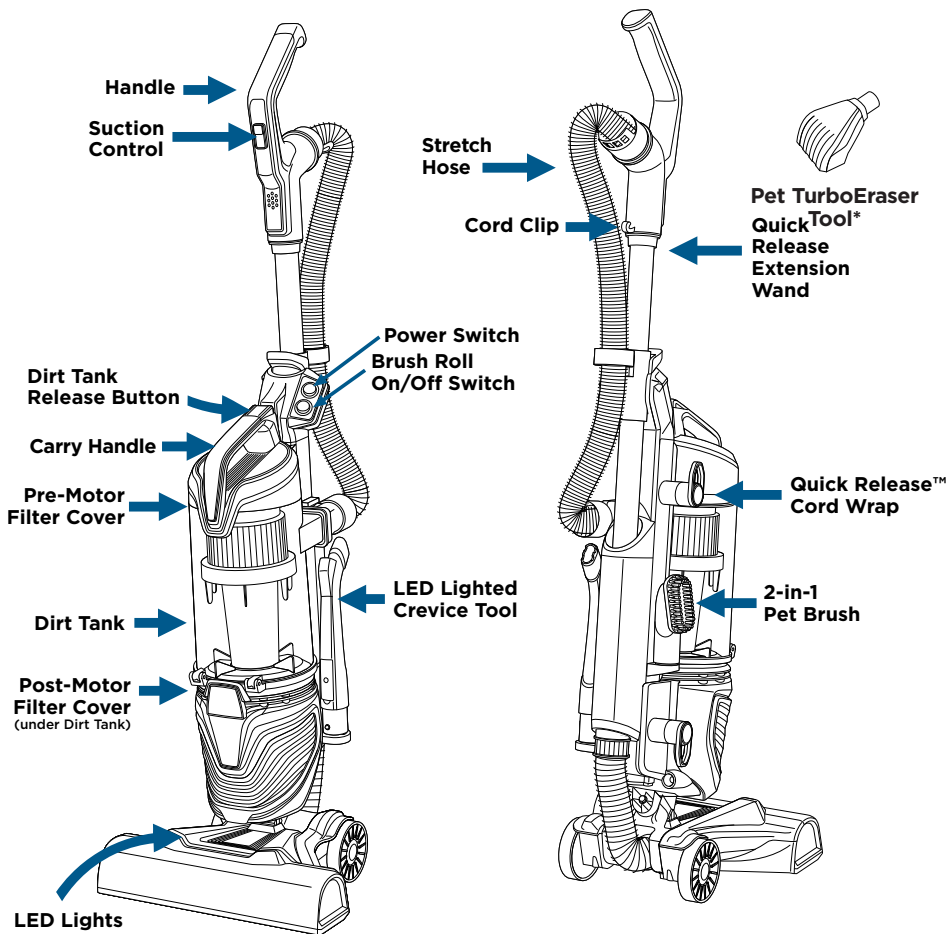

***NOTE:** Pet TurboEraser Tool does not store on unit.

Operations

WARNING

Do not plug in your vacuum until you are familiar with all instructions and operating procedures.

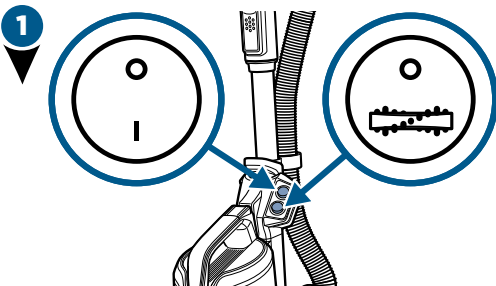

1 Turn vacuum ON by pressing Power Switch on (I - ON and O - OFF). Press Brush Roll switch to run the PowerBrush for carpet cleaning (Brush Roll is ON when light on switch is illuminated). See page 15 to maintain the Brush Roll.



2 Step gently on base and pull back on handle to recline.

NOTE: The Brush Roll will automatically shut OFF when vacuum is locked in upright position. Recline to reactivate.

NOTE: In the unlikely event that hair wrapped around your Brush Roll, run vacuum back and forth on clean carpet several times to help release any wrapped hair.

NOTE: Turn OFF the Brush Roll when vacuuming hard or delicate surfaces that may be caught by the rotating brush. This could include hard wood, tiled floors, small area rugs, or frieze carpets that have long delicate fibers or threads.

Adjusting the Suction Control

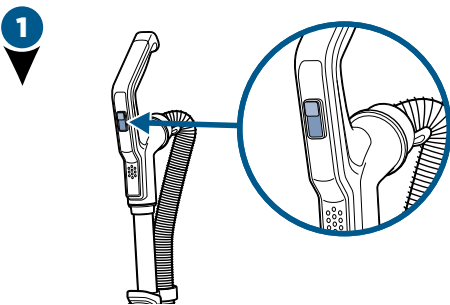

1 Locate the Suction Control setting on the vacuum handle. Adjust Suction Control for plush carpet or low carpet for easy multi-surface cleaning.

Above Floor Cleaning

1

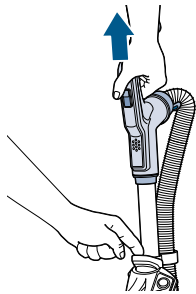

Clean hard to reach spaces with the Quick Release Extension Wand. Push the release button to remove and attach desired tool.

2

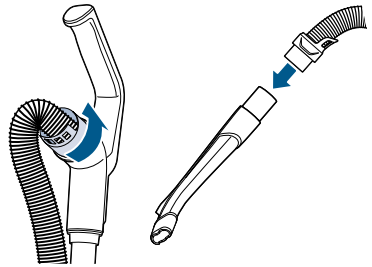

If desired, the Stretch Hose can be removed from the Extension Wand. To do so, twist hose from the back of the wand to remove.

3

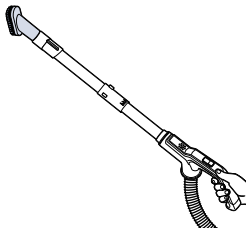

Attach desired tool. Use the Pet TurboEraser Tool for best results on stairs. Or use the 2-in-1 Pet Brush with soft, white bristles for sensitive/gentle surfaces and rubber nubs to pick up embedded pet hair.

4

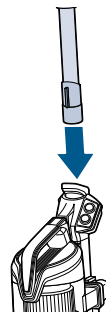

When finished, replace the wand back on the vacuum by sliding into place until you hear “click”.

Vacuum Motor Protection

An internal thermal protector has been designed into your vacuum to protect it from overheating. When the thermal protector activates, the main vacuum motor will stop operating. The front lights will remain on, even though the motor turns off. If this happens, proceed as follows.

- 1** Turn vacuum OFF and unplug from electrical outlet.
- 2** Check for the source of overheating problem (full Dirt Tank, dirty filters, or a clog) and fix by following the maintenance instructions.
- 3** When the motor cools for approximately 30 minutes, the thermal protector automatically resets and cleaning may continue. If the vacuum will not turn on or the thermal protector continues to activate, your vacuum may need servicing. Contact BISSELL Consumer Care.

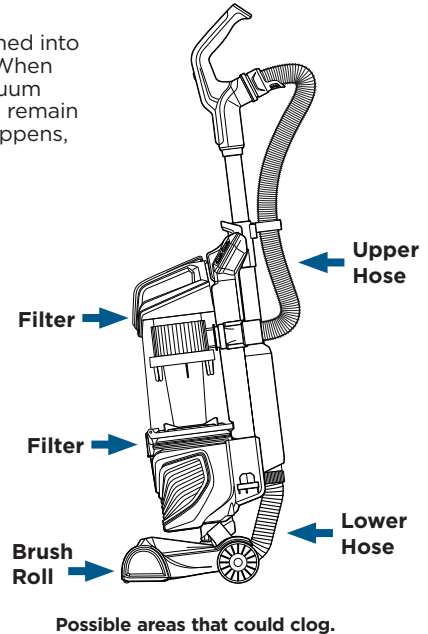

NOTE: The thermal protector controls the main vacuum motor only, not the brush motor. If the thermal protector activates, brush and lights will continue to operate normally; however, there will be no suction.

Remove/Empty Dirt Tank

⚠️ WARNING

To reduce the risk of electrical shock, turn power switch OFF and disconnect plug from electrical outlet before performing maintenance or troubleshooting checks.

1

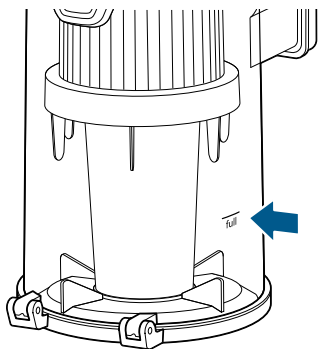

The Dirt Tank is full. Time to empty!

2

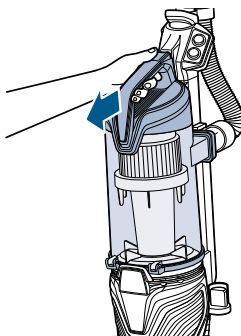

Press the Tank Release Button and grab the handle to pull the Dirt Tank away from vacuum.

3

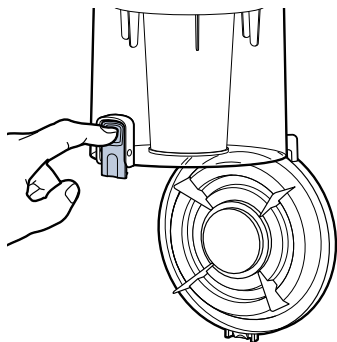

Hold the Dirt Tank over a trash bin and press the Empty Button. Once emptied, snap bottom back into place.

4

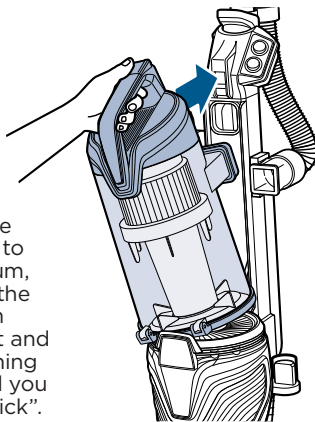

Return the Dirt Tank to the vacuum, securing the bottom in place first and then pushing back until you hear a "click".

⚠️ WARNING

Do not operate vacuum with damp or wet filters. Allow components to dry before reassembling the Dirt Tank.

⚠️ WARNING

Before using your vacuum, make sure that the Dirt Tank is in locked position and that all filters, both pre- and post-filters, are in place. DO NOT operate your vacuum without these filters.

Clean/Replace Pre-Motor Filters



⚠️ WARNING

To reduce the risk of electrical shock, turn power switch OFF and disconnect plug from electrical outlet before performing maintenance or troubleshooting checks.

⚠️ WARNING

Do not operate vacuum with damp or wet filters. Allow components to dry before reassembling the dirt container.

1

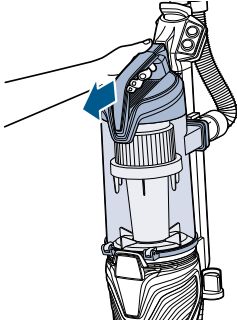

Press the Dirt Tank Release Button and pull away from vacuum.

2

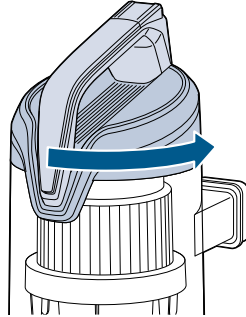

Twist tank cover to the unlock position then pull up on handle.

3

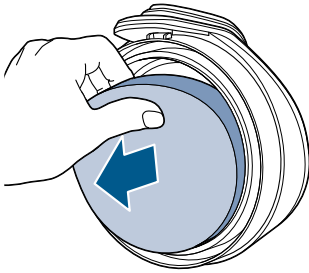

Remove Pre-Motor Filter from top of Dirt Tank lid by pulling out.

4

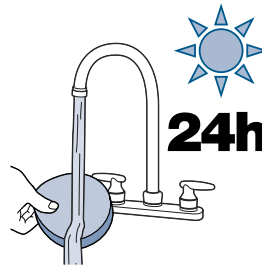

Both Pre-Motor Felt and Foam Filters are washable. Clean with mild detergent, rinse and squeeze all excess water. Allow filters to dry completely before reinserting. Return Pre-Motor Filters to the top of the Dirt Tank, placing the thick Foam Filter in last.

NOTE: Replace filters every 3 to 6 months. Visit BISSELL.com.au for filter replacements.

Clean/Replace Post-Motor Filter



⚠️ WARNING

To reduce the risk of electrical shock, turn power switch OFF and disconnect plug from electrical outlet before performing maintenance or troubleshooting checks.

⚠️ WARNING

Do not operate vacuum with damp or wet filters. Allow components to dry before reassembling the Dirt Tank.

1

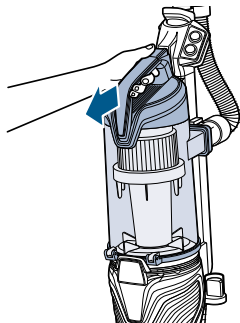

Press the Dirt Tank Release Button and pull Dirt Tank away from vacuum.

2

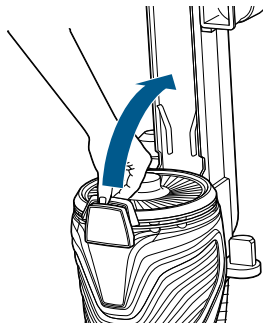

Pull tab up to access Post-Motor Filter.

3

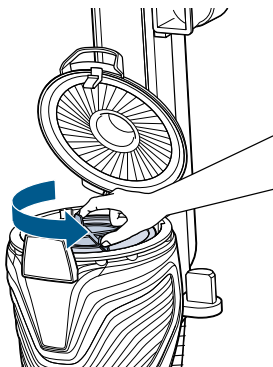

Twist filter counter-clockwise to unlock and remove from vacuum.

4

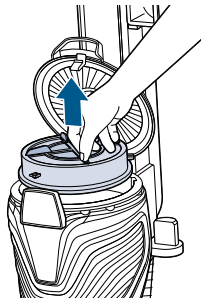

When reassembling, be sure to lock the filter back into place. The pleated filter may NOT be washed. If dust/debris accumulates, gently tap the filter on the inside of a trash container.

NOTE: Replace filters every 3 to 6 months. Visit BISSELL.com.au for filter replacements.

Clean Inner Cyclone Separator

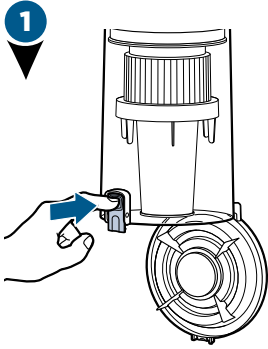

Hold the Dirt Tank over a trash container. Press the bottom release button to empty.

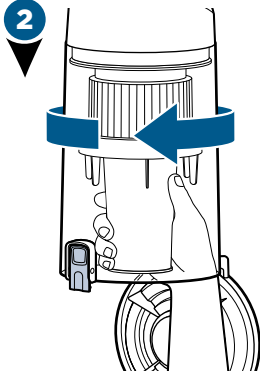

Twist Cyclone counter-clockwise and pull down to remove from tank.

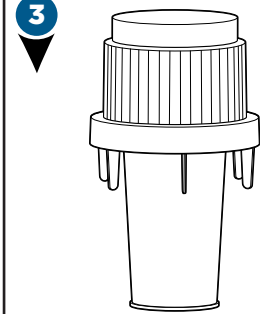

Tap separator against inside of trash container and rinse under warm water, if necessary. Be sure to let it dry completely before placing back in Dirt Tank.

Maintain Pet TurboEraser Tool

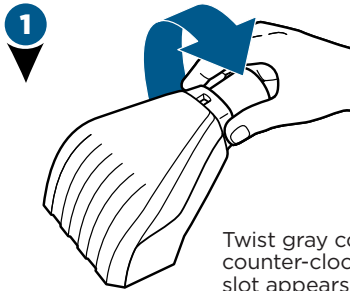

Twist gray collar counter-clockwise, until slot appears, and then separate faceplate.

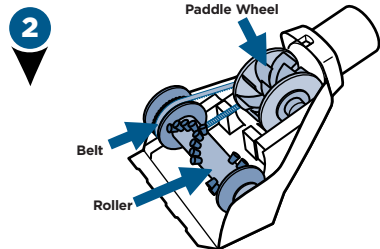

Remove Brush Roll, Belt and Paddle Wheel. Inspect for damages and replace if necessary.

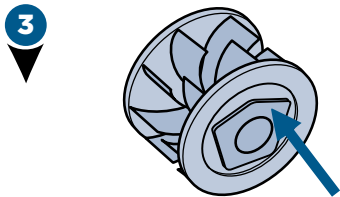

To reassemble, align two clips on each end of Paddle Wheel with Belt on and pop back into place. Place Brush Roll with Belt back in. Faceplate will not close properly if all parts are not aligned correctly.

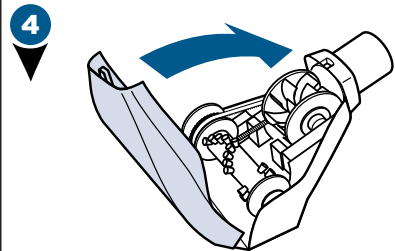

To put faceplate back on, align the tabs in the top of the cover and place it down to "click" into place.

Replace Brush and Belt

1

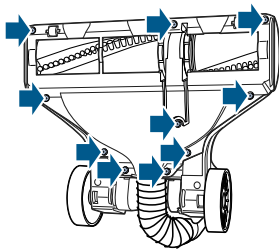

Unplug and turn vacuum over. Unscrew 10 Phillips-head screws to remove bottom cover.

2

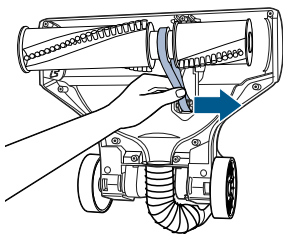

Pull Brush Roll straight out and slide Belt off motor gear. Replace Brush Roll and/or Belt.

3

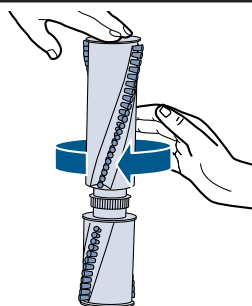

Inspect Brush Roll by placing it on its end and spin. The Brush Roll should spin freely, multiple times by one flick. If it doesn't, replace Brush Roll. Inspect Belt, replace if it appears damaged.

4

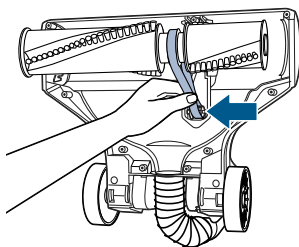

1. Place Belt back on Brush Roll.
2. Pinch Belt around Brush Roll & hook back around the motor gear.

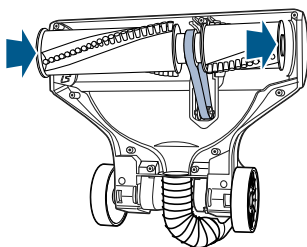

3. Rotate Brush Roll into place and line up end caps.
4. Re-attach bottom cover with 10 screws.

NOTE: If an object becomes lodged in foot and brush shuts off, turn vacuum OFF and unplug from electrical outlet. Remove obstruction and brush will automatically reset when vacuum is plugged and turned back ON.

Troubleshooting

WARNING

To reduce the risk of electric shock, turn power switch OFF and disconnect plug from electrical outlet before performing maintenance or troubleshooting checks.

Problem	Possible causes	Remedies
Brush Roll doesn't rotate	Brush Roll switch is turned OFF.	Make sure Brush Roll switch is ON.
	Vacuum is locked in upright position.	Recline vacuum and switch on the Brush Roll.
	Vacuumping on Premium Soft Carpet.	Adjust Suction Control to reduce suction on softer carpets.
	Brush Roll has lodged debris or other entanglements, keeping the brush from rotating.	Unplug to reset brush motor, checking for and removing debris before turning ON.
Vacuum won't pick up dirt	Filters are dirty.	Remove and rinse Pre-Motor Filters. Allow enough time for them to dry properly before reinserting. Remove and dust off post-motor filter.
	There is a clog in the vacuum.	Remove bottom cover and check for any buildup of debris. Remove debris and debris buildup before reinstalling bottom cover.
	Dirt Tank is not seated correctly.	Press the Tank Release to release the Dirt Tank and reseal properly.
	There is a crack or hole in the Main Hose.	If there is a crack or hole, order a new Main Hose from the BISSELL website.
	Main Hose is not connected.	Locate the Main Hose and reconnect by pushing the hose connection.
	There is a clog in the hose.	Disconnect Lower Hose and check for clogs as well. Use a broom handle to push any debris out.
	Hair wrapped around Brush Roll.	Run vacuum back and forth on clean carpet several times to release wrapped hair.
Dirt is escaping from the vacuum	Dirt Tank is full.	Empty the Dirt Tank.
	Filters are missing or dirty.	Check to see if all of the Pre-Motor and Post-Motor Filters are in place and clean.
Hose won't pick up dirt	Suction is set too low.	Adjust using the Suction Control Feature.
Vacuum is hard to push or pull	Suction is set too high.	Adjust using the Suction Control Feature.
High-pitched noise	There is a clog in the vacuum.	Check inside of Main Hose and Lower Hose for clogs by disconnecting from vacuums.

Consumer Guarantee

This Guarantee gives you specific legal rights, in addition to rights you may have under the Australian consumer law. If you need additional instruction regarding this Guarantee or have questions regarding what it may cover, please contact your local BISSELL Consumer Services on the details set out below.

Limited 2 Year Guarantee (from the date of purchase by original purchaser)

Subject to whether the *CONDITIONS identified below, BISSELL will repair or replace (with new, refurbished, lightly used, or remanufactured components or products), at BISSELL's option, free of charge, any defective or malfunctioning part due to manufacturer defect. This Guarantee applies to product used for personal purposes, and not commercial or rental service. This Guarantee does not apply to fans or routine maintenance or consumable components such as filters, belts, brush rolls, etc., damage or malfunction caused by negligence, abuse, neglect, unauthorised repair, or any other use not in accordance with the user's guide. BISSELL recommends that the original packaging be kept for the duration of the Guarantee period in case such need arises within the Guarantee period that the item needs re-packing and transportation.

*CONDITIONS OF THE GUARANTEE

Subject to whether such loss is reasonably foreseeable, BISSELL and its in-country distributors are not liable for incidental or consequential damages of any nature associated with the use of this product.

FOR AUSTRALIAN CONSUMERS ONLY:

OUR GOODS COME WITH GUARANTEES THAT CANNOT BE EXCLUDED UNDER THE AUSTRALIAN CONSUMER LAW. YOU ARE ENTITLED TO A REPLACEMENT OR REFUND FOR A MAJOR FAILURE AND FOR COMPENSATION FOR ANY OTHER REASONABLY FORESEEABLE LOSS OR DAMAGE. YOU ARE ALSO ENTITLED TO HAVE THE GOODS REPAIRED OR REPLACED IF THE GOODS FAIL TO BE OF ACCEPTABLE QUALITY AND THE FAILURE DOES NOT AMOUNT TO A MAJOR FAILURE.

THIS GUARANTEE IS IN ADDITION TO OTHER RIGHTS OR REMEDIES UNDER LAW. NOTHING IN THIS GUARANTEE EXCLUDES, LIMITS OR MODIFIES ANY LIABILITY OF BISSELL WHICH IS IMPOSED BY LAW, OR LIMITS OR MODIFIES ANY REMEDY AVAILABLE TO THE CONSUMER WHICH IS GRANTED BY LAW. TO MAKE A CLAIM UNDER THIS GUARANTEE CONTACT BISSELL AUSTRALIA PTY LTD (DETAILS ABOVE). CONTACT BISSELL PRIOR TO RETURNING ANY GOODS. WHERE AGREED, BISSELL WILL REIMBURSE REASONABLE POSTAGE / HANDLING COSTS (IF ANY) FOR RETURNING GOODS TO BISSELL. TO CLAIM EXPENSES INCURRED IN MAKING A CLAIM UNDER THIS GUARANTEE PLEASE PROVIDE BISSELL WITH A COPY OF THE RECEIPT OF THE EXPENSES BY EMAIL OR POST.

Consumer Care

If your BISSELL product should require service or to claim under our limited guarantee, please contact us as follows:

Website and Email:

www.bissell.com.au
www.bissell.co.nz

Telephone:

Australia: 1300-247-735
New Zealand: 0800-247-735

Write:

BISSELL AUSTRALIA PTY LIMITED
42 Rocco Dr.
Scoresby 3179
Victoria
Australia

Replacement parts and accessories are available for purchase. To purchase visit www.BISSELL.com.au.

Visit the BISSELL website: www.BISSELL.com.au

When contacting BISSELL, have model number of cleaner available.

Please record your Model Number: _____ Please record your Purchase Date: _____

NOTE: Please keep your original sales receipt. It provides proof of the date of purchase in the event of a Guarantee claim. See Guarantee for details.



©2018 BISSELL Homecare, Inc
Grand Rapids, Michigan
All rights reserved. Printed in China
Part Number 161-5513 10/18
Visit our website at: www.BISSELL.com.au