

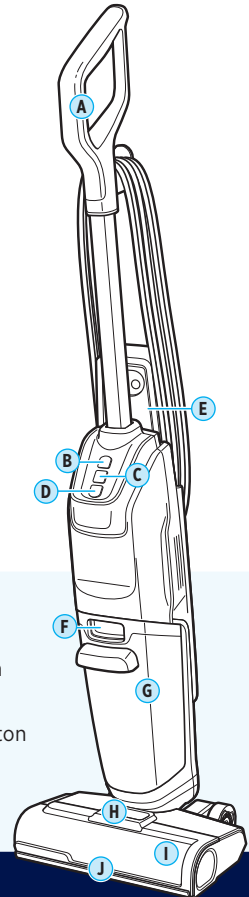

CROSSWAVE[®] EDGEFIND[®]

ALL-IN-ONE MULTI SURFACE CLEANER

Important Safety Instructions	2
What's in the Box?	3
Assembly	3
Filling the Clean Water Tank	4
Cleaning Your Floors	4
Emptying the Dirty Water Tank	5
Using the Clean-Out Cycle	6
Changing the Brush Roll	6
After-Cleaning Care	7
Storing Your Machine	7
Troubleshooting	8
Warranty	8



Product Overview

- | | |
|---------------------------|-------------------------------------|
| A. Handle | F. Dirty Water Tank Release Button |
| B. Power Button | G. Dirty Water Tank with Filter |
| C. Multi-Surface Button | H. Brush Roll Window Release Button |
| D. Clean-out Cycle Button | I. Brush Roll Window |
| E. Clean Water Tank | J. FurFinder™ Headlights |

Meet your new BISSELL[®] product!

Go to <https://bissell.com.au/pages/contact> for a walkthrough of your new purchase, including videos, tips, support, and more. Want to get started right away? This guide has all the information you need to set up your new product. Let's take a look...

SYMBOL	EXPLANATION
	Caution.
	Read operator's manual.
	Risk of fire.
	Risk of electric shock.
	For indoor use only.
	Do not overwet carpet. Use only on carpet moistened by the cleaning process.
	Use only BISSELL® cleaning formulas intended for use with this machine.
	Disconnect power before servicing.
	Protection against moving parts.
	Risk of automatic start-up.

SYMBOL	EXPLANATION
	This symbol on the product and/or accompanying documents means that used electrical and electronic products should not be mixed with general household waste. For proper treatment, recovery and recycling, please take this product to designated collection points. Please contact your local authority for further details of your nearest designated collection point.
	Allow parts to dry.
	Use warm water, temperature up to 60°C.
	Check the manufacturer's tag before cleaning textile. "W" on the tag as shown means you can use your cleaner.
	Lock.
	Do not freeze.
	Clean out cycle. Automatic self-cleaning cycle after use.
	Area Rug. Small area rug cleaning mode.
	Hard Floor. Hard floor cleaning mode.
	Paper.

IMPORTANT SAFETY INSTRUCTIONS



READ ALL INSTRUCTIONS BEFORE USING YOUR APPLIANCE.

When using an electrical appliance, basic precautions should be observed, including the following:



WARNING

TO REDUCE THE RISK OF FIRE, ELECTRIC SHOCK OR INJURY:

- This appliance is not intended for use by persons (including children) with reduced physical, sensory or mental capabilities, or lack of experience and knowledge, unless they have been given supervision or instruction concerning use of the appliance by a person responsible for their safety.
- Children should be supervised to ensure that they do not play with the appliance. Cleaning and user maintenance shall not be made by children without supervision.
- Plastic film can be dangerous. To avoid danger of suffocation, keep away from children.
- Keep hair, loose clothing, fingers, and all parts of body away from openings and moving parts of the appliance and its accessories.
- Floor slippery when wet.
- The plug must be removed from the socket-outlet before cleaning or maintaining the appliance.
- If appliance is not working as it should, has been dropped, damaged, left outdoors, or dropped into water; do not attempt to operate it and have it repaired at an authorized service center.
- Do not put any object into openings. Do not use with any opening blocked; keep free of dust, lint, hair, and anything that may reduce air flow.
- Use extra care when cleaning on stairs.
- Do not use to pick up flammable or combustible materials (lighter fluid, gasoline, kerosene, etc.) or use in areas where they may be present.
- Do not use appliance in an enclosed space filled with vapours given off by oil base paint, paint thinner, some moth-proofing substances, flammable

dust, or other explosive or toxic vapours.

- If the supply cable is damaged, it must be replaced by the manufacturer, its service agent or similarly qualified person in order to avoid a hazard.
- Do not pull or carry by cable, use cable as a handle, close door on cable, or pull cable around sharp edges or corners. Keep cable away from heated surfaces.
- Do not leave appliance when plugged in. Unplug from outlet when not in use and before servicing.
- Do not handle plug or appliance with wet hands.
- Turn OFF all controls before plugging or unplugging appliance.
- Do not turn your appliance ON until you are familiar with all instructions and operating procedures.
- Do not expose to rain. Store indoors.
- Always connect to a properly earthed electrical socket. Do not modify earthed plug.
- Liquid must not be directed towards equipment containing electrical components.
- Do not immerse. Use only on surfaces moistened by the cleaning process. Use only BISSELL cleaning products intended for use with this machine.
- Do not use for any purpose other than described in this user guide. Use only manufacturer's recommended attachments.
- Use only the type and amount of liquids specified under the operations section of this guide.
- Risk of injury from moving parts. brush may start unexpectedly. Unplug before cleaning or servicing.
- Use indoors only.
- Always install float before any wet pick-up operation.
- A hazard may occur if the appliance runs over the supply cord.
- The appliance has to be unplugged after use and before carrying out user maintenance on the appliance.
- Do not unplug by pulling on cable. To unplug, grasp the plug, not the cable.
- Do not use without filters in place.

SAVE THESE INSTRUCTIONS

ORIGINAL INSTRUCTIONS.

FOR OPERATION ON A 220-240 VOLT A.C. 50-60 HZ POWER SUPPLY ONLY.

THIS MODEL IS FOR HOUSEHOLD USE ONLY.

COMMERCIAL USE OF THIS UNIT VOIDS THE MANUFACTURER'S WARRANTY.

IMPORTANT INFORMATION

- To reduce the risk of a leaking condition, do not store where freezing may occur. Damage to internal components may result.
- Plastic tanks are not dishwasher safe. Do not put tanks in dishwasher.
- Do not turn ON your appliance until you are familiar with all instructions and operating procedures.
- Keep appliance on a level surface.

WARNING



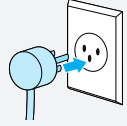

Improper connection of the equipment-grounding conductor can result in a risk of electrical shock. Check with a qualified electrician or service person if you aren't sure if the outlet is properly grounded. **DO NOT MODIFY THE PLUG.** If it will not fit the outlet, have a proper outlet installed by a qualified electrician. This appliance is designed for use on a nominal 220-240 volt circuit, and has a grounding attachment plug that looks like the plug in the illustration. Make certain that the appliance is connected to an outlet having the same configuration as the plug. No plug adapter should be used with this appliance.

GROUNDING INSTRUCTIONS

This appliance must be connected to a grounded wiring system. If it should malfunction or break down, grounding provides a safe path of least resistance for electrical current, reducing the risk of electrical shock. The cord for this appliance has an equipment-grounding conductor and a grounding plug. It must only be plugged into an outlet that is properly installed and grounded in accordance with all local codes and ordinances.

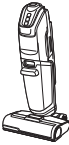

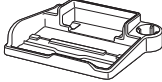
What's in the Box?

				
Body	Handle	Trial Formula	Tray	Clean Tank

Assembly



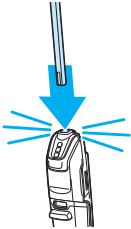
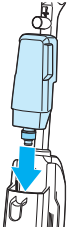
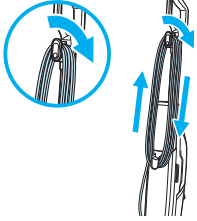

		
1. Install handle until it clicks into place.	2. Install clean tank into back of machine until it clicks into place.	3. Wrap cord. To easily unwrap, turn Quick Release™ Cord Wrap down.

Note: Remove cardboard insert from bottom of foot before first use.

Filling the Clean Water Tank

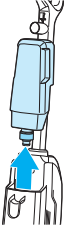
For optimal performance, use genuine BISSELL® formulas in your machine. Other formulas or household cleaners may cause defects or damage to the machine.

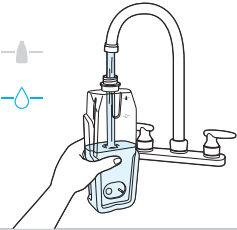
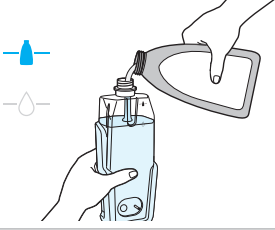
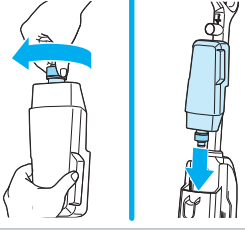
		
<p>1. Choose your formula.* Scan the QR code with your smartphone camera or visit BISSELL.com for formulas.</p>	<p>2. Pull clean water tank up to remove.</p>	<p>3. Unscrew cap.</p>
		
<p>4. Fill clean water tank with warm water (140°F/60°C) to water fill line (21 fl. oz.).</p>	<p>5. Add formula* to the formula line (3 fl. oz.).</p>	<p>6. Screw cap back on. Align clean water tank with grooves on back of machine and install until it clicks into place.</p>

*Compatible BISSELL formulas include: Multi-Surface, Wood Floor, PET Multi-Surface with Ambipur, Hard Floor Sanitise, Simply Multi-Surface Pet, Pet Pro Oxy. FEBREZE is used under license from The Procter & Gamble Company or its affiliates.

Cleaning Your Floors

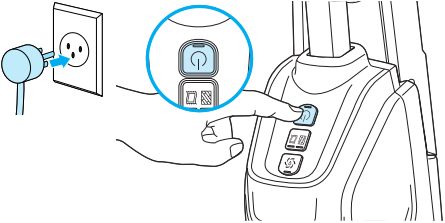
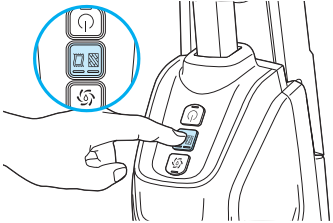

	
<p>1. Plug machine into a properly grounded outlet. Press power button to turn machine ON. Default mode is Hard Floor Mode.</p>	<p>2. Press multi-surface button to toggle between modes:</p> <p>Hard Floor: Everyday messes on sealed hard floors, like tracked-in mud, spilled cereal and milk, coffee, and more.</p> <p>Area Rug: Refresh and clean dry messes, like crumbs, dirt, hair, and more.</p>

Cleaning Your Floors (continued)

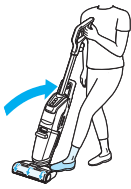

3. Recline machine to start brush roll spinning and spray. Machine will dispense cleaning fluid automatically while machine is reclined. Brush roll and spray stops when machine is placed upright.



4. It may take up to 15 seconds to fully wet brush roll. For best results, move machine forward to wet floor. Use steady forward and backward strokes to ensure consistent performance. Solution will dispense automatically. The float will engage when the tank is full. Listen for change in sound of the device. Follow instructions on page 5 to empty dirty tank.

Cleaning with Hard Floor Sanitise Formula

Please read "DIRECTIONS FOR USE" on Hard Floor Sanitise label. Use on hard nonporous floors only.



1. Remove visible soil before cleaning. Make forward and backward passes.

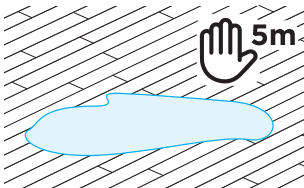

2. Allow floor to remain visibly wet with formula for five minutes. This may require additional passes.



3. Make forward and backward passes to extract formula. Allow to air dry. Solution will dispense automatically.

Emptying the Dirty Water Tank

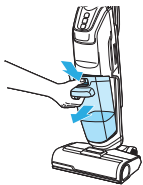

1. Press dirty tank release button while grabbing dirty tank handle and pull out to remove.



2. To remove lid hold top of tank near sides of filter and pull up to remove.

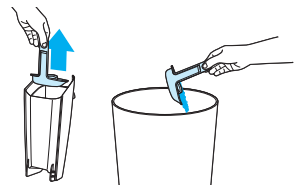

3. Pull strainer tab up and out of tank to separate debris from dirty water. Dispose of debris.

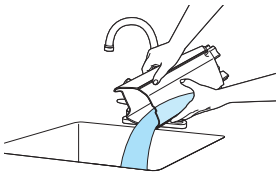

4. Pour dirty water into a sink or similar wastewater receptacle and thoroughly rinse tank.

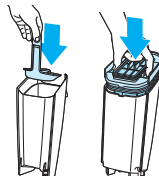

5. Reassemble dirty water tank by placing strainer back in tank and placing lid back on the dirty water tank.

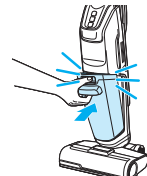

6. Insert bottom of tank first. Tilt tank towards machine until it clicks into place.

Using the Clean-Out Cycle

Note: Empty dirty water tank before beginning and make sure filter stays dry. Use clean-out cycle after each use to clean out your machine so that you can store it with confidence.

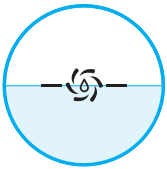
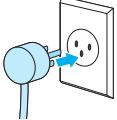
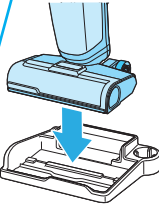
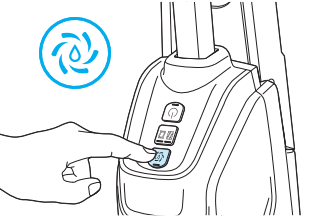
	 	
<p>1. Make sure water reaches clean-out cycle line on clean water tank. Refill with water if needed.</p>	<p>2. Plug in machine and place in storage tray.</p>	<p>3. Press the clean-out cycle button to begin. Run time is 40 seconds long. Empty dirty tank after running clean-out cycle. It is recommended to remove brush roll and place in brush roll holder on dock to air dry.</p>

Changing the Brush Roll

Visit BISSELL.com to purchase additional brush rolls.

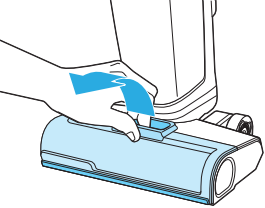
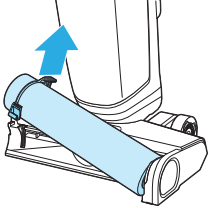
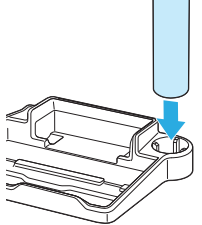

		
<p>1. Press brush roll window release and pull window towards you to remove.</p>	<p>2. Pull brush roll tab to remove.</p>	<p>3. Place brush roll in brush roll holder on dock to air dry.</p>

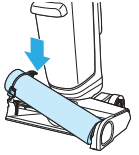
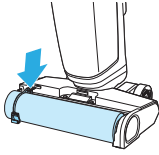
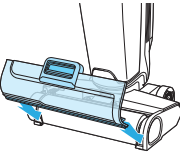
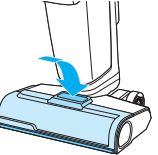
			
<p>4. To install brush roll, insert right side of brush roll first and rotate downward until tab on left side of brush is locked in place.</p>		<p>5. Install window by lining up tabs on bottom edges of foot and rotating towards machine. Press down until window clicks into place.</p>	

After-Cleaning Care

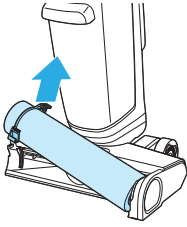

1. Remove brush roll window and brush roll. Place brush roll in holder on dock. Allow brush roll to dry for 24 hours before reinstalling (see page 6).

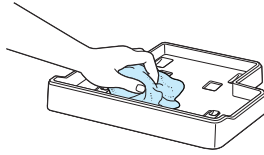

2. Remove machine from tray and wipe excess water or dirt.

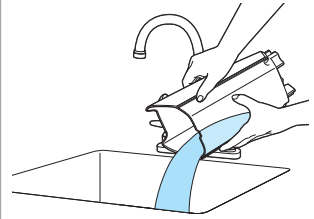

3. Empty dirty water tank.



4. Remove filter from lid. Open screen and remove debris.

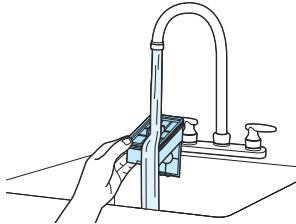

5. Wash filter in warm water. Clean and dry filter after each use. Replace every 3 months.

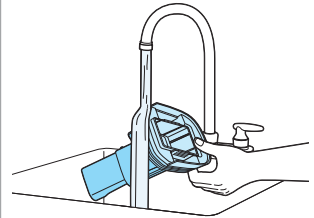

6. Rinse the tank lid and float to remove any debris and ensure float moves freely.

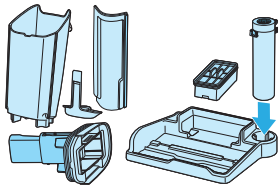

7. Let parts air dry completely before installing.
Note: A wet filter will impact suction performance.

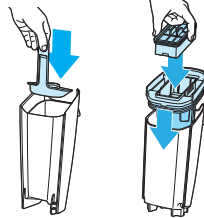

8. Reassemble dirty water tank by placing strainer back in tank, inserting filter into lid, and placing lid back on the dirty water tank.

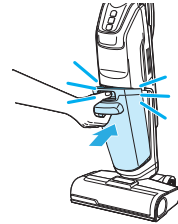

9. Insert bottom of tank first. Tilt tank towards machine until it clicks into place.

Note: Any other maintenance or servicing not included in this manual should be performed by an authorized service representative.

Storing Your Machine

When finished using the product, wrap cord around cord wrap for storage. Store unit indoors in a dry location in an area where the product is not likely to get damaged.

Replace filter and brush roll as needed about every 3 months.

Troubleshooting

Problem	Possible Cause	Remedies
Reduced or no spray	Clean water tank may be empty or seated incorrectly.	Refill and reinstall the clean water tank.
	System isn't completely primed.	Ensure clean tank is full and allow machine to run for 15-20 seconds to fully prime.
	Clean tank filter is dirty.	Remove clean tank from machine. Locate small white foam filter under where tank connects to body. Clean debris from foam filter and reinstall.
Loss of suction or streaking	Tanks may not be seated properly.	Remove both tanks and reseal them so they fit properly on machine.
	Dirty water tank is full.	Empty dirty water tank.
	Brush window is not latched in place.	Unplug machine and reinstall window.
	Debris channel in foot is clogged by debris.	Clean channel with a paper towel.
Brush roll is not turning	Filter clogged by debris.	Remove debris clogging filter screen and clean filter.
	Brush roll is not installed properly.	Follow instructions on page 6 for replacing brush roll.
	Machine is standing upright.	Step on foot and recline body of machine to turn brush roll on.
Machine is leaking	Brush roll stalled by debris.	Unplug machine. Remove brush window and brush roll to remove obstruction.
	Cap of clean water tank is not closed properly.	Remove clean water tank and reinstall cap. Make sure cap is align and secured.
Machine stops running and two lights of mode button are blinking	Machine may be overheating.	Press power button to clear error. Remove brush roll cover and any debris stuck near the brush roll.
Machine stops running and two lights of mode button are blinking and clean-out cycle light is blinking	Machine may be overheating.	Press power button to clear error. Remove brush roll and any debris stuck near the brush roll.

Warranty

Limited 3-year warranty, may vary by state. Visit <https://bissell.com.au/pages/contact> or call 1300-247-735 for complete warranty information.

Terms and Conditions

Your purchase is subject to the BISSELL® Terms and Conditions, which includes dispute resolution through arbitration and class waiver. For complete terms or to opt out from arbitration or class waiver, visit [BISSELL.com/terms-of-use](https://bissell.com/terms-of-use) or call 1300-247-735.

Need more support?

Head to <https://bissell.com.au/pages/contact> to troubleshoot, register your product, order spare parts, view your warranty and more



INFO



REGISTER



VIDEOS



PARTS



SUPPORT